

MDR-10 Series

10W Single Output Industrial DIN Rail Power Supply



Features :

- Universal AC input/Full range
- Protections: Short circuit / Overload / Over voltage
- Cooling by free air convection
- Can be installed on DIN rail TS-35/7.5 or 15
- Built in DC OK active signal
- LED indicator for power on
- No load power consumption<0.75W
- 100% full load burn-in test
- 3 years warranty



GTIN CODE

MW Search: <https://www.meanwell.com/serviceGTIN.aspx>



SPECIFICATION

MODEL	MDR-10-5	MDR-10-12	MDR-10-15	MDR-10-24	
OUTPUT	DC VOLTAGE	5V	12V	15V	24V
	RATED CURRENT	2A	0.84A	0.67A	0.42A
	CURRENT RANGE	0 ~ 2A	0 ~ 0.84A	0 ~ 0.67A	0 ~ 0.42A
	RATED POWER	10W	10W	10W	10W
	RIPPLE & NOISE (max.) Note.2	80mVp-p	120mVp-p	120mVp-p	150mVp-p
	VOLTAGE TOLERANCE Note.3	± 5.0%	± 3.0%	± 3.0%	± 2.0%
	LINE REGULATION	± 1.0%	± 1.0%	± 1.0%	± 1.0%
	LOAD REGULATION	± 5.0%	± 3.0%	± 3.0%	± 2.0%
	SETUP, RISE TIME Note.5	500ms, 30ms/230VAC	1000ms, 30ms/115VAC at full load		
HOLD UP TIME (Typ.)	120ms/230VAC	25ms/115VAC at full load			
INPUT	VOLTAGE RANGE	85 ~ 264VAC	120 ~ 370VDC		
	FREQUENCY RANGE	47 ~ 63Hz			
	EFFICIENCY (Typ.)	77%	81%	81%	84%
	AC CURRENT (Typ.)	0.33A/115VAC	0.21A/230VAC		
	INRUSH CURRENT (Typ.)	COLD START 35A/115VAC	70A/230VAC		
LEAKAGE CURRENT	<1mA / 240VAC				
PROTECTION	OVERLOAD	Above 105% rated output power Protection type : Hiccup mode, recovers automatically after fault condition is removed			
	OVER VOLTAGE	5.75 ~ 6.75V	13.8 ~ 16.2V	17.25 ~ 20.25V	27.6 ~ 32.4V
		Protection type : Shut down o/p voltage, re-power on to recover			
FUNCTION	DC OK ACTIVE SIGNAL (max.)	3.75 ~ 6V / 50mA	9 ~ 13.5V / 40mA	11.5 ~ 16.5V / 40mA	18 ~ 27V / 20mA
ENVIRONMENT	WORKING TEMP.	-20 ~ +70 (Refer to "Derating Curve")			
	WORKING HUMIDITY	20 ~ 90% RH non-condensing			
	STORAGE TEMP., HUMIDITY	-40 ~ +85 , 10 ~ 95% RH			
	TEMP. COEFFICIENT	± 0.03%/ (0 ~ 50)			
SAFETY & EMC (Note 4)	VIBRATION	Component:10 ~ 500Hz, 2G 10min./1cycle, 60min. each along X, Y, Z axes; Mounting: Compliance to IEC60068-2-6			
	SAFETY STANDARDS	UI508, TUV BS EN/EN62368-1, EAC TP TC 004, BSMI CNS15598-1, AS/NZS 62368.1, IS13252(Part1)/IEC60950-1 approved			
	WITHSTAND VOLTAGE	I/P-O/P:3KVAC I/P-FG:2KVAC O/P-FG:0.5KVAC			
	ISOLATION RESISTANCE	I/P-O/P, I/P-FG, O/P-FG:100M Ohms / 500VDC / 25 / 70% RH			
	EMC EMISSION	Compliance to BS EN/EN55032 (CISPR32), BS EN/EN61204-3 Class B, BS EN/EN61000-3-2,-3, EAC TP TC 020, CNS15936 Class B			
EMC IMMUNITY	Compliance to BS EN/EN61000-4-2, 3, 4, 5, 6, 8, 11, BS EN/EN55035,BS EN/EN61000-6-1,BS EN/EN61204-3, light industry level, EAC TP TC 020				
OTHERS	MTBF	3334.7K hrs min. Telcordia SR-332 (Bellcore) ; 584.0K hrs min. MIL-HDBK-217F (25)			
	DIMENSION	22.5*90*100mm (W*H*D)			
	PACKING	0.15Kg; 72pcs/11.8Kg/1.04CUFT			
NOTE	<ol style="list-style-type: none"> 1. All parameters NOT specially mentioned are measured at 230VAC input, rated load and 25 of ambient temperature. 2. Ripple & noise are measured at 20MHz of bandwidth by using a 12" twisted pair-wire terminated with a 0.1μ F & 4μ F parallel capacitor. 3. Tolerance : includes set up tolerance, line regulation and load regulation. 4. The power supply is considered a component which will be installed into a final equipment. The final equipment must be re-confirmed that it still meets EMC directives. For guidance on how to perform these EMC tests, please refer to "EMI testing of component power supplies." (as available on https://www.meanwell.com/Upload/PDF/EMI_statement_en.pdf) 5. Length of set up time is measured at cold first start. Turning ON/OFF the power supply may lead to increase of the set up time. 6. The ambient temperature derating of 3.5 /1000m with fanless models and of 5 /1000m with fan models for operating altitude higher than 2000m(6500ft). Product Liability Disclaimer : For detailed information, please refer to https://www.meanwell.com/serviceDisclaimer.aspx 				

MDR-10 Series

10W Single Output Industrial DIN Rail Power Supply



Mechanical Specification

Case No. 956

(Unit: mm, tolerance ± 1 mm)

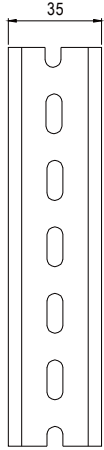

Install DIN rail TS35/7.5 or TS35/15

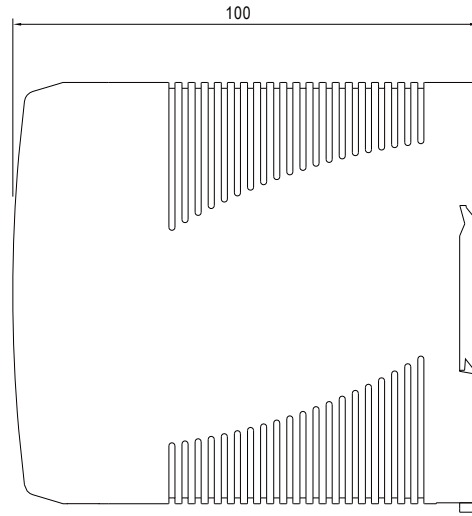
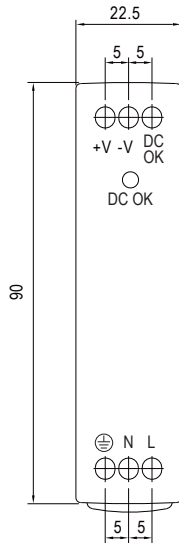

Block Diagram

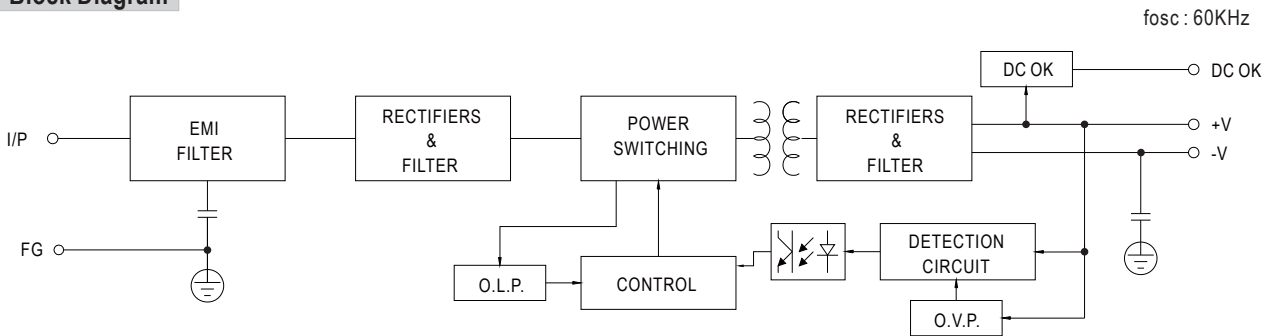

Application of DC OK Active Signal

(a) 5V signal

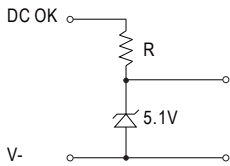

Model	R
5V	20 Ω
12V	1.5 Ω
15V	2 Ω
24V	3.9 Ω

(b) LED

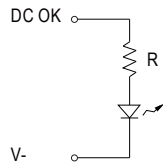

Model	R
5V	1 Ω
12V	2.4 Ω
15V	3 Ω
24V	4.7 Ω

(c) Relay

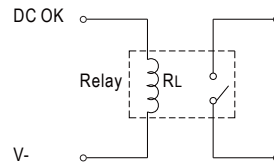

Model	RL
5V	12 Ω
12V	70 Ω
15V	70 Ω
24V	1.2 Ω

Derating Curve

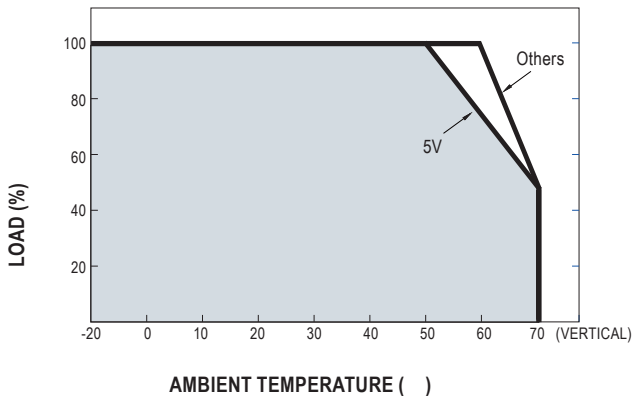

Output Derating VS Input Voltage

