

RSDH-150 Series

150W High Reliable 250~1500Vdc Ultra Wide Input DC-DC Converter



Features

- 250~1500Vdc 6:1 ultra-wide input range
- Withstand 1700Vdc surge input for 10 seconds
- 4KVac I/O high isolation(Reinforced isolation)
- Protections: Short circuit / Overload / Over voltage / Over temperature
DC input under voltage / DC input reverse polarity
- Fanless design, half encapsulated, cooling by free air convection
- -40~+80°C ultra-wide operating temperature (> +55°C derating)
- Over voltage category II
- Operating altitude up to 5000 meters
- DC output voltage adjustable(12~15V, 24~29V, 30~36V, 48~58V)
- 1U low profile 41mm
- Half encapsulated
- 3 years warranty

Applications

- Photovoltaic power generation
- Renewable energy system
- High voltage frequency conversion
- Industrial control system
- Semiconductor fabrication equipment
- Electro-mechanical apparatus
- DC bus centralized application
- Energy storage system(ESS)
- Charging pile
- Third rail

GTIN CODE

MW Search: <https://www.meanwell.com/serviceGTIN.aspx>

Description

RSDH-150 series is a 250 ~ 1500Vdc ultra-high input enclosed type DC-DC converter which can supply stable working voltage for the load. Main features are as following: -40~+80° C wide range operating temperature, 4KVac high isolation voltage, operation at 5000m altitude, high efficiency, low ripple & noise, complete protections and so on.

RSDH-150 is compliant with UL1741 and BS EN/EN-61000-6-2 standard regarding immunity for industrial environments. It is suitable for industrial automation, surveillance, telecommunication and can be widely deployed in the applications of new energy generation such as solar power, and windmill power generation, for instances, photovoltaic power systems, high voltage inverting, DC bus centralized application, ESS, charging pile, railway and so forth.

Model Encoding

RSDH - 150 - 24

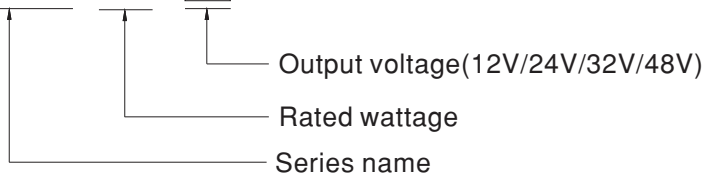

RSDH-150 Series

150W High Reliable 250~1500Vdc Ultra Wide Input DC-DC Converter



SPECIFICATION

MODEL		RSDH-150-12	RSDH-150-24	RSDH-150-32	RSDH-150-48	
OUTPUT	DC VOLTAGE	12V	24V	32V	48V	
	RATED CURRENT	10A	6.2A	4.68A	3.12A	
	CURRENT RANGE	0 ~ 10A	0 ~ 6.2A	0 ~ 4.68A	0 ~ 3.12A	
	RATED POWER	120W	150W	150W	150W	
	RIPPLE & NOISE (max.) Note.2	120mVp-p	240mVp-p	240mVp-p	300mVp-p	
	VOLTAGE ADJ. RANGE	12 ~ 15V	24 ~ 29V	30 ~ 36V	48 ~ 58V	
	VOLTAGE TOLERANCE Note.3	± 1.5%	± 1.0%	± 1.0%	± 1.0%	
	LINE REGULATION	± 0.5%	± 0.5%	± 0.5%	± 0.5%	
	LOAD REGULATION	± 1.5%	± 1.5%	± 1.0%	± 1.0%	
EXTERNAL CAPACITANCE LOAD (Max.)	4000 μ F	2500 μ F	2000 μ F	1000 μ F		
INPUT	VOLTAGE RANGE Note.4	250 ~ 1500Vdc				
	EFFICIENCY (Typ.)	300Vdc	88%	88%	88%	90%
		800Vdc	88%	90%	91%	92%
		1500Vdc	85%	86%	87%	88%
	INRUSH CURRENT (max.)	COLD START 300A/1500Vdc 200A/800Vdc 70A/250Vdc				
EXTERNAL INPUT FUSE	4A/1500VDC, required (Please refer to page 4 for more details)					
PROTECTION	OVERLOAD	105 ~ 135% rated output power Protection type : Hiccup mode when output voltage<55%, recovers automatically after condition is removed; Constant current limiting, recovers automatically after fault condition is removed within 55% ~ 100% rated output voltage				
	OVER VOLTAGE	16.5 ~ 21V	33 ~ 42V	40 ~ 48V	62 ~ 70V	
		Protection type : Hiccup mode, recovers automatically after fault condition is removed				
	OVER TEMPERATURE	Protection type : Hiccup mode, recovers automatically after fault condition is removed				
	DC INPUT	REVERSE POLARITY	By internal Bridge Diode, no damage , recovers automatically after fault condition removed			
UNDER VOLTAGE LOCKOUT		Under voltage protection range: 200 ~ 225Vdc , Under voltage release range:225 ~ 246.5Vdc				
ENVIRONMENT	WORKING TEMP.	-40 ~ +80°C (Refer to "Derating Curve")				
	WORKING HUMIDITY	20 ~ 90% RH non-condensing				
	STORAGE TEMP., HUMIDITY	-40 ~ +80°C, 10 ~ 95% RH non-condensing				
	TEMP. COEFFICIENT	± 0.03%/°C (0 ~ 55°C)				
	VIBRATION	Component: 10 ~ 500Hz, 3G 10min./1cycle, 60min. each along X, Y, Z axes; Mounting clip: Compliance to IEC60068-2-6				
	OPERATING ALTITUDE Note.5	5000m				
	OVER VOLTAGE CATEGORY	OVC II 2000m; According to EN62109-1				
SAFETY & EMC (Note.6)	SAFETY STANDARDS	UL1741, CSA C22.2 No.107.1-16 , IEC62109-1, BS EN/EN62109-1, EAC TP TC 004 approved				
	WITHSTAND VOLTAGE	I/P-O/P:4KVAC I/P-FG:3.75KVAC O/P-FG:2KVAC				
	ISOLATION RESISTANCE	I/P-O/P, 100M Ohms / 500VDC / 25°C / 70% RH				
	EMC EMISSION	Parameter	Standard	Test Level / Note		
		Conducted	BS EN/EN55032(CISPR32)	Class A		
		Radiated	BS EN/EN55032(CISPR32)	Class A		
	EMC IMMUNITY	BS EN/EN55035, BS EN/EN61000-6-2				
		Parameter	Standard	Test Level /Note		
		ESD	BS EN/EN61000-4-2	Level 3, 8KV air; Level 2, 4KV contact, criteria A		
		Radiated Susceptibility	BS EN/EN61000-4-3	Level 3, 10V, criteria A		
EFT/Burest		BS EN/EN61000-4-4	Level 3, 2KV, criteria A			
Surge		BS EN/EN61000-4-5	Level 4, 2KV/Vin+ ~ Vin-, 4KV Vin-FG			
Conducted		BS EN/EN61000-4-6	Level 3, 10V, criteria A			
Magnetic Field	BS EN/EN61000-4-8	Level 4, 30A, criteria A				
OTHERS	MTBF	1924.7K hrs min. Telcordia SR-332 (Bellcore); 285.9K hrs min. MIL-HDBK-217F (25°C)				
	DIMENSION	191*86*41mm (L*W*H)				
	PACKING	0.81Kg;12pcs/10.7Kg/0.75CUFT				
NOTE	<p>1. All parameters NOT specially mentioned are measured at 800Vdc input, rated load and 25°C of ambient temperature.</p> <p>2. Ripple & noise are measured at 20MHz of bandwidth by using a 12" twisted pair-wire terminated with a 0.1 μf & 47 μf parallel capacitor.</p> <p>3. Tolerance : includes set up tolerance, line regulation and load regulation.</p> <p>4. Derating may be needed under low input voltage. Please check the derating curve for more details.</p> <p>5. The ambient temperature derating of 3.5°C/1000m with fanless models and of 5°C/1000m with fan models for operating altitude higher than 2000m(6500ft).</p> <p>6. The power supply is considered a component which will be installed into a final equipment. The final equipment must be re-confirmed that it still meets EMC directives. For guidance on how to perform these EMC tests, please refer to "EMI testing of component power supplies." (as available on https://www.meanwell.com/Upload/PDF/EMI_statement_en.pdf)</p> <p>※ Product Liability Disclaimer : For detailed information, please refer to https://www.meanwell.com/serviceDisclaimer.aspx</p>					

RSDH-150 Series

150W High Reliable 250~1500Vdc Ultra Wide Input DC-DC Converter



Block Diagram

fosc : 65KHz

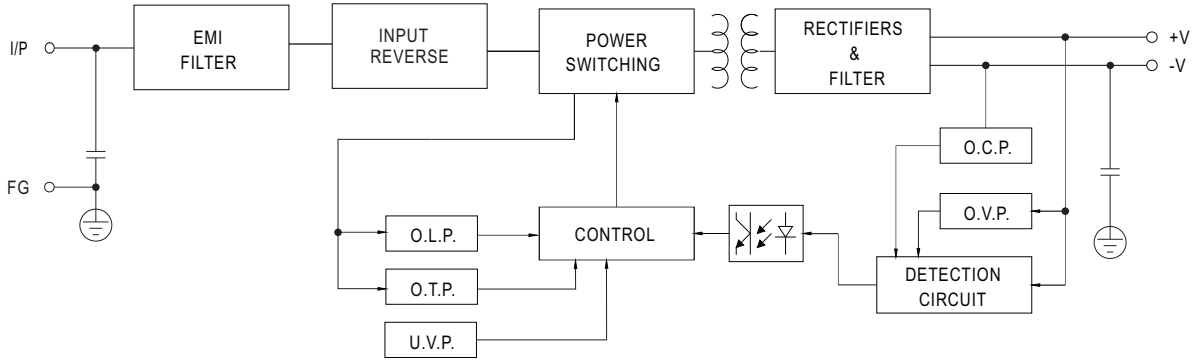

Derating Curve

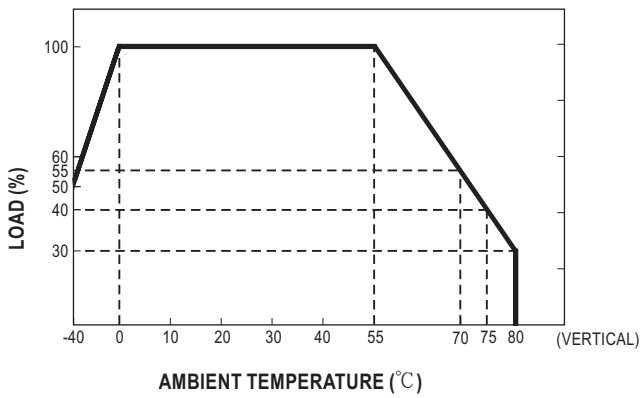

Static Characteristics

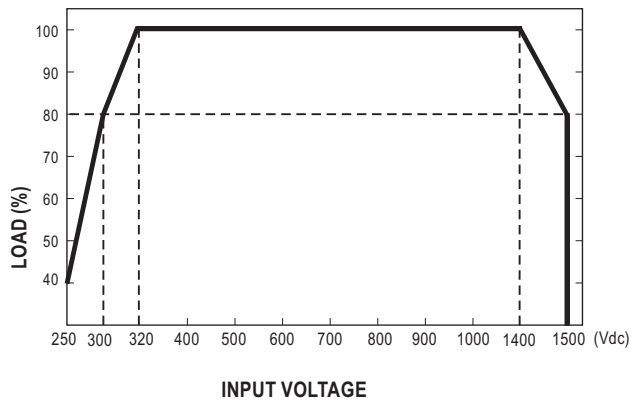

Altitude Curve

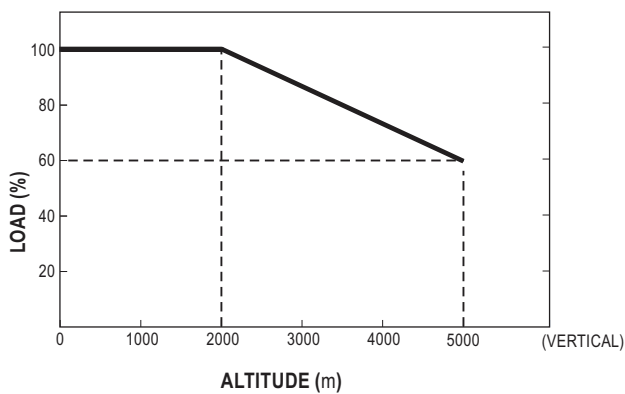

Note: Multiply by the regular power limit factor

RSDH-150 Series

150W High Reliable 250~1500Vdc Ultra Wide Input DC-DC Converter



Mechanical Specification

(Unit: mm , tolerance ± 1 mm)

Case No.203B

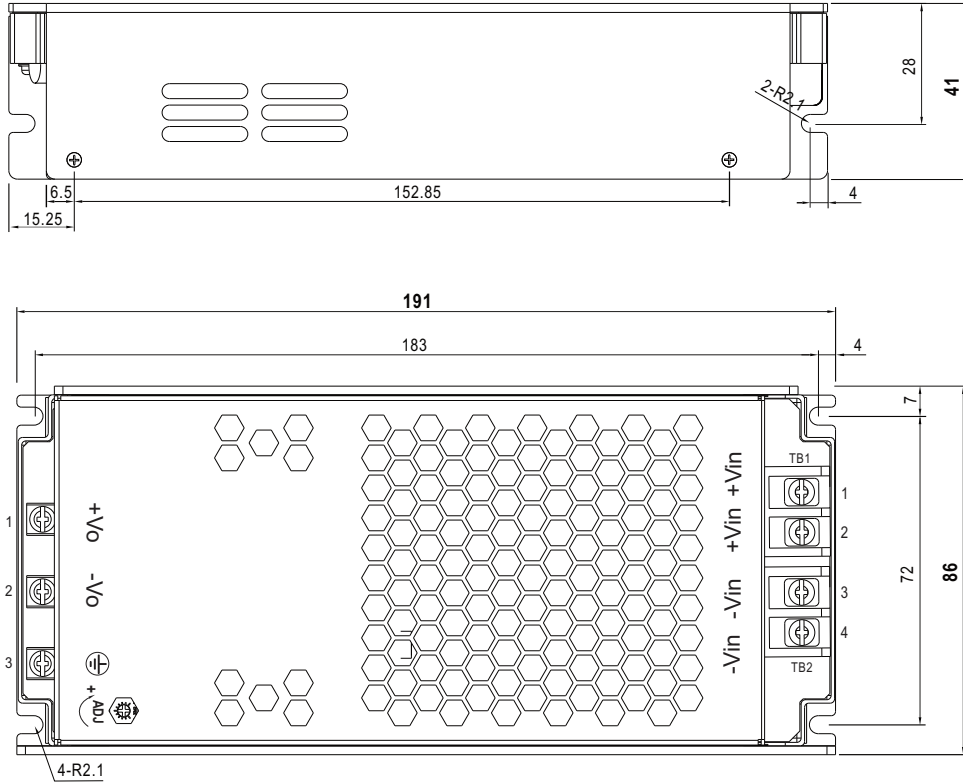

Output Terminal Pin No. Assignment

Pin No.	Assignment
1	+Vo
2	-Vo
3	FG

Input Terminal Pin No. Assignment (TB1,TB2)

Pin No.	Assignment
1	+Vin
2	+Vin
3	-Vin
4	-Vin

External FUSE wiring instruction

External FUSE is required.FUSE specification : 4A/1500Vdc.

Suggested model:

Fuse Brand	Manufacturer Part NO.		MW's Order NO.
	Fuse	Fuse Holder	Fuse + Fuse Holder
WalterFuse	WJ30-4	WJ30-H	WJ30-4_WJ30-H

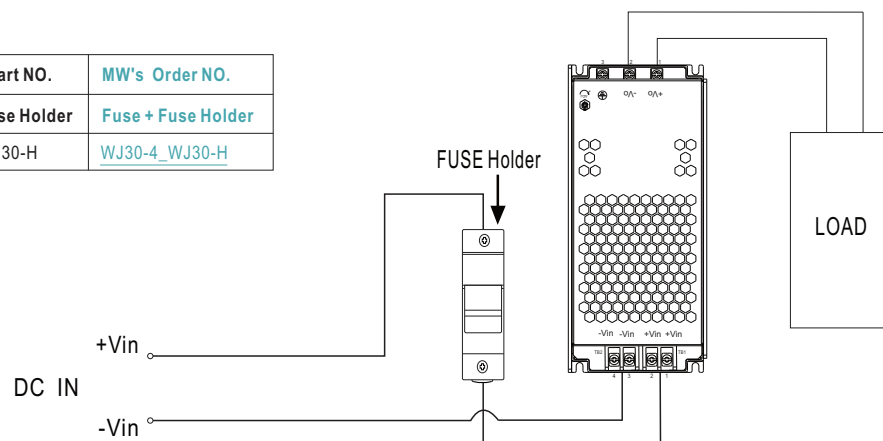

Installation Manual

Please refer to : <http://www.meanwell.com/manual.html>