

XLC-60-KN Series

60W Multiple-Stage Constant Power LED Driver



XLC-60-KN-S Series
(Independent type)



XLC-60-KN Series
(Built-in type)



■ Features

- Constant power mode output with multiple stage selectable by ETS database
- Plastic housing with class II and PFC design
- Flicker free, complying with CE ErP directive
- Standby power consumption <0.5W
- Meet emergency lighting (EL) application
- KNX/EIB protocol, support KNX data secure
- Minimum dimming level 0.5%
- Functions: operation hours, power consumption feedback log/linear curve selection. . . etc
- 5 years warranty

■ Applications

- Recessed Light
- Down Light
- Panel Light
- Commercial Lighting
- Decorative Lighting
- KNX digital Lighting

■ GTIN CODE

MW Search: <https://www.meanwell.com/serviceGTIN.aspx>

■ Description

XLC-60-KN Series is a 60W with constant power output LED driver . It can operate from 100 ~ 305VAC and output current ranging between 900mA to 1700mA selectable by ETS database and integration KNX interface to avoid using the complicated KNX-DALI gateway. Thanks to high efficiency up to 90%, it is able to operate for -25°C ~90°C case temperature under free air convection. XLC-60-KN is designed based on latest safety regulations , so it provides more flexibility for LED Lighting application.

■ Model Encoding

XLC - 60 - H - KN □

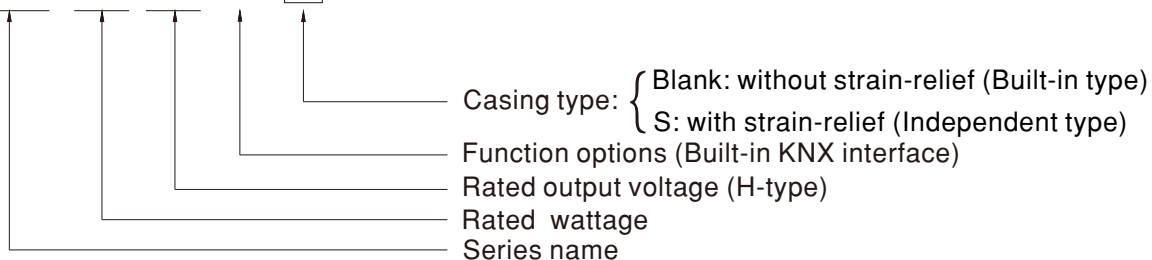

Type	Function	Note
KN	Built-in KNX interface, without strain-relief (Built-in type)	In stock
KNS	Built-in KNX interface, with strain-relief (Independent type)	In stock

SPECIFICATION

MODEL		XLC-60-H-KN □		
OUTPUT	OPEN CIRCUIT VOLTAGE <small>Note2</small>	60V		
	DEFAULT CURRENT	900mA		
	CURRENT ADJ. RANGE (BY ETS Database)	0.9~1.7A		
	CONSTANT CURRENT REGION	9~54V		
	RATED POWER <small>Note4</small>	60W		
	CURRENT RIPPLE <small>Note5</small>	<4%		
	CURRENT TOLERANCE	±5%		
	DIMMING RANGE	0~100%		
SETUP,RISE TIME <small>Note6</small>	800ms,100ms/230VAC ,1000ms,100ms/115VAC			
INPUT	VOLTAGE RANGE	100 ~ 305VAC 155 ~400VDC		
	FREQUENCY RANGE	47 ~ 63Hz		
	POWER FACTOR	PF ≥0.95/115VAC, PF ≥0.95/230VAC, PF ≥0.9/277VAC@full load (Please refer to "POWER FACTOR (PF) CHARACTERISTIC" section)		
	TOTAL HARMONIC DISTORTION	THD< 20%(@load ≥60%/230VAC; @load ≥75%/277VAC); THD<10%@load 100%/230VAC (Please refer to "TOTAL HARMONIC DISTORTION(THD)" section)		
	EFFICIENCY(Typ.) <small>Note7</small>	90%		
	AC CURRENT	0.75A/115VAC, 0.35A/230VAC, 0.3A/277VAC		
	INRUSH CURRENT	COLD START 15A(twidth=310µs measured at 50% Ipeak) at 230VAC; Per NEMA 410		
	MAX. NO. of PSUs on 16A CIRCUIT BREAKER	25 units (circuit breaker of type B) / 36 units (circuit breaker of type C) at 230VAC		
	LEAKAGE CURRENT	<0.75mA / 277VAC		
	STANDBY POWER <small>Note8</small> CONSUMPTION	Standby power consumption<0.5W (Dimming off)		
PROTECTION	SHORT CIRCUIT	Hiccup mode, recovers automatically after fault condition is removed		
	OVER TEMPERATURE	Stage 1: De-rating to 75% loading; Stage 2: De-rating to 50% loading. Recovers automatically after fault condition is removed.		
FUNCTION	DIMMING	Please refer to 'DIMMING OPERATION' section		
ENVIRONMENT	WORKING TEMP.	Tcase=-25~90°C (Please refer to "OUTPUT LOAD vs TEMPERATURE" section)		
	MAX. CASE TEMP.	Tcase=90°C		
	WORKING HUMIDITY	20 ~ 90% RH non-condensing		
	STORAGE TEMP., HUMIDITY	-40 ~ +80°C, 10 ~ 95% RH		
	TEMP. COEFFICIENT	±0.03%/°C (0 ~ 50°C)		
	VIBRATION	10 ~ 500Hz, 2G 10min./1cycle, period for 60min. each along X, Y, Z axes		
SAFETY&EMC	SAFETY STANDARDS	ENEC BS EN/EN61347-1, BS EN/EN61347-2-13(EL) appendix J suitable for emergency installations (DC input 176-280VDC); BS EN/EN62384 , GB/T19510.1, GB/T19510.213, EAC TP TC 004 approved; Design refer to AS/NZS 61347-1, AS/NZS 61347-2-13		
	WITHSTAND VOLTAGE	I/P-O/P:3.75KVAC		
	ISOLATION RESISTANCE	I/P-O/P:>100M Ohms / 500VDC / 25°C / 70% RH		
	EMC EMISSION	Parameter	Standard	Test Level/Note
		Conducted	BS EN/EN55015(CISPR15) ,GB/T 17743	-----
		Radiated	BS EN/EN55015(CISPR15) ,GB/T 17743	-----
		Harmonic Current	BS EN/EN61000-3-2 , GB17625.1	Class C @load≥60%
	EMC IMMUNITY	Parameter	Standard	Test Level/Note
		ESD	BS EN/EN61000-4-2	Level 3, 8KV air ; Level 2, 4KV contact
		Radiated	BS EN/EN61000-4-3	Level 2
EFT/Burst		BS EN/EN61000-4-4	Level 2	
Surge		BS EN/EN61000-4-5	Level 3, 1KV/Line-Line	
Conducted		BS EN/EN61000-4-6	Level 2	
Magnetic Field		BS EN/EN61000-4-8	Level 2	
Voltage Dips and Interruptions	BS EN/EN61000-4-11	70% residual voltage for 10 period, 0% residual voltage for 0.5 periods		
OTHERS	KNX	Certified protocol		
	FLICKER <small>Note9</small>	PstLM ≤ 1, SVM ≤ 0.4		
	MTBF	4130.5K hrs min. Telcordia SR-332 (Bellcore)	317.7Khrs min. MIL-HDBK-217F (25°C)	
	DIMENSION	176*45*32mm , 136*45*32mm (L*W*H)		
	PACKING	0.28Kg; 40pcs/12.1Kg/0.48CUFT(for blank type);	0.31Kg; 40pcs/13.1Kg/0.61CUFT(for S-type)	
NOTE	<ol style="list-style-type: none"> All parameters NOT specially mentioned are measured at 230VAC input, rated current and 25°C of ambient temperature. Output hiccups under no-load condition. Please refer to "DRIVER METHODS OF LED MODULE". De-rating may be needed under low input voltages. Please refer to "STATIC CHARACTERISTIC" sections for details. Current ripple is measured 50%~100% of maximum voltage under rated power delivery. Length of set up time is measured at first cold start. Turning ON/OFF the driver may lead to increase of the set up time. Efficiency is measured at 1050mA/54V output set by ETS database. Standby power consumption is measured at 230VAC. Flicker is measured at full load with the light source provided by MEAN WELL. The driver is considered as a component that will be operated in combination with final equipment. Since EMC performance will be affected by the complete installation, the final equipment manufacturers must re-qualify EMC Directive on the complete installation again. (as available on https://www.meanwell.com/Upload/PDF/EMI_statement_en.pdf) For XLC-S series: RCM is on a voluntary basis. Non IC classification Independent LED control gear is not suitable for residential installations. For XLC(except -S) series: RCM is on a voluntary basis and meets relevant IEC or AS/NZS standards complying with AS/NZS 4417.1. The ambient temperature derating of 3.5°C/1000m with fanless models and of 5°C/1000m with fan models for operating altitude higher than 2000m(6500ft). This series meets the typical life expectancy of 50000 hours of operation when Tcase, particularly tc point (or TMP, per DLC), is about 75°C or less. For more information, please contact with MEAN WELL sales. ※ Product Liability Disclaimer: For detailed information, please refer to https://www.meanwell.com/serviceDisclaimer.asp 			

XLC-60-KN Series

60W Multiple-Stage Constant Power LED Driver



■ BLOCK DIAGRAM

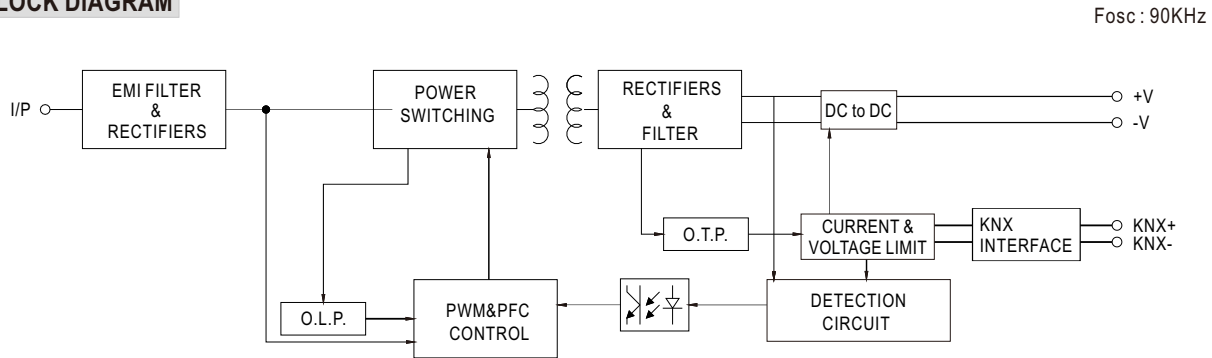

■ DRIVING METHODS OF LED MODULE

※ I-V Operating Area

◎ XLC-60-H-KN

For 60W application

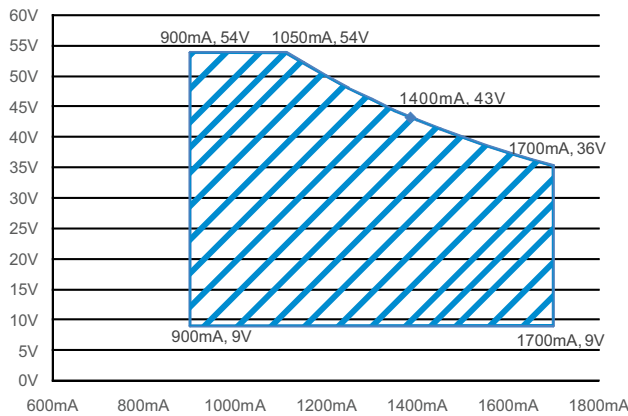

■ CONSTANT POWER TABLE

XLC-60-KN is a multiple-stage constant power driver, selection of output current through Database.

Vo	Io	Vo	Io
9~54V	900mA(Default)	9~45V	1350mA
9~54V	950mA	9~43V	1400mA
9~54V	1000mA	9~41V	1450mA
9~54V	1050mA	9~40V	1500mA
9~54V	1100mA	9~39V	1550mA
9~52V	1150mA	9~38V	1600mA
9~50V	1200mA	9~37V	1650mA
9~48V	1250mA	9~36V	1700mA
9~46V	1300mA		

■ DIMMING OPERATION

※ KNX interface

- Apply KNX Bus cable between KNX+ and KNX-
- The application program(database) can be downloaded via Online Catalogs from ETS or via <http://www.meanwell.com/productCatalog.aspx>

Parametrization options	Description
Device Setting	<ul style="list-style-type: none"> • Select current level • Select model • Behavior bus power up
Parameter Setting	<ul style="list-style-type: none"> • Basic Setting <ul style="list-style-type: none"> • normal Dimmer, staircase light • switch function • relative dimming function • absolute dimming function • Feedback Setting <ul style="list-style-type: none"> • dimming value report • on/off state report • lamp failure report • Lock function
Scenes	<ul style="list-style-type: none"> • Learn scene • scene1~scene32
Automatic function	<ul style="list-style-type: none"> • Automatic function1~4
operating hours	<ul style="list-style-type: none"> • Counting of operating hours • Constant light output(CLO) • Life time pre-warning
Power consumption	<ul style="list-style-type: none"> • Voltage, current, power feedback • Energy consumption feedback
Temperature Measurement	<ul style="list-style-type: none"> • customize the alarm temperature • Send temperature report cyclically
Auto-dimming over time	<ul style="list-style-type: none"> • Optional gradient dimming
Correction characteristic	<ul style="list-style-type: none"> • Correction by lux measured value(lux)
Push Dim Port	<ul style="list-style-type: none"> • Push dim • AC monitor

※ CONSTANT LIGHT OUTPUT

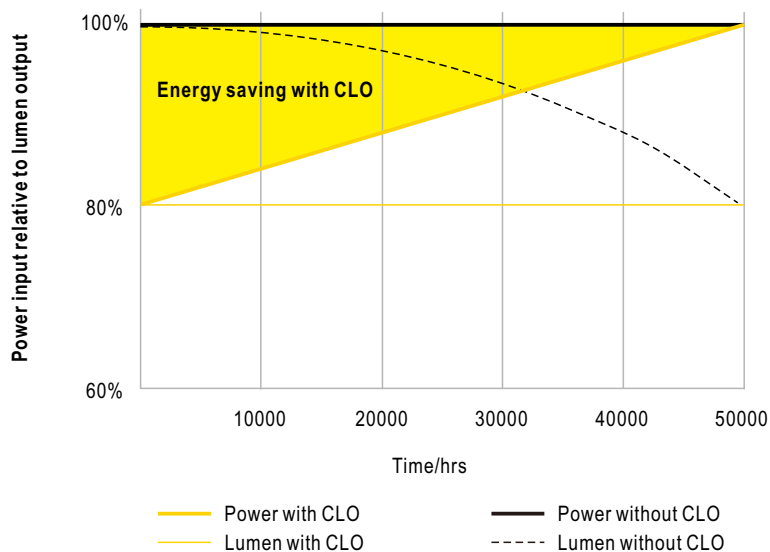

※ PUSH dimming or AC/DC input monitor(Primary side)

◎ PUSH dimming

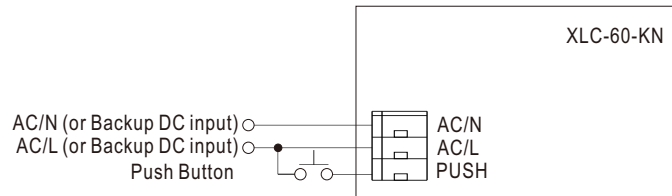

- KNX bus need to be connected when using PUSH Dimming
- The detailed function of PUSH dimming, please refer to the database.
- The maximum length of the cable between the push button and driver is 20 meters.
- The mechanical push button can be connected only between the PUSH terminal, as displayed in the diagram, and AC/L (in brown or black); It will not function properly if it is connected to AC/N.
- In case the PUSH dimming is set locally, up to 10 drivers can perform the PUSH dimming at the same time when utilizing one common push button.
- In case the PUSH dimming is set independently via ETS, the number of drivers is done through group address and determined by the ETS project designer.

◎ AC/DC input monitor

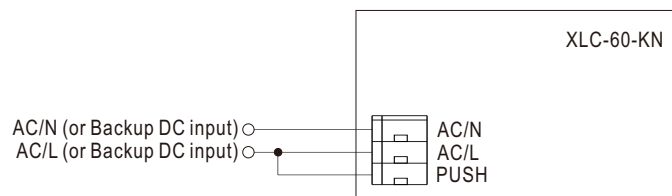

- KNX bus need to be connected when using AC/DC input monitor
- The detailed function of AC/DC input monitor(emergency lighting), please refer to the database and instruction manual.

XLC-60-KN Series

60W Multiple-Stage Constant Power LED Driver



OUTPUT LOAD vs TEMPERATURE

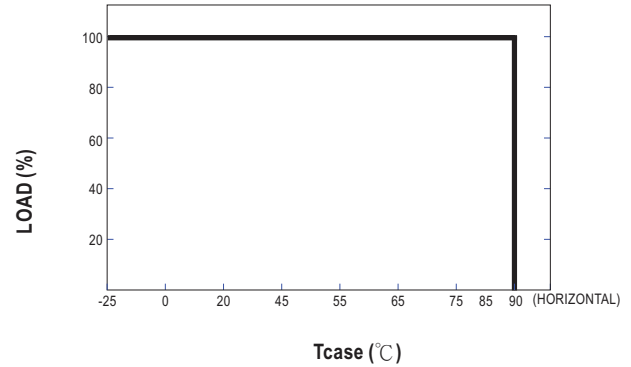
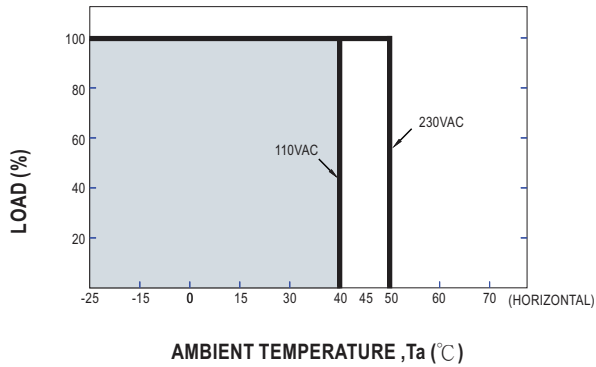

STATIC CHARACTERISTIC

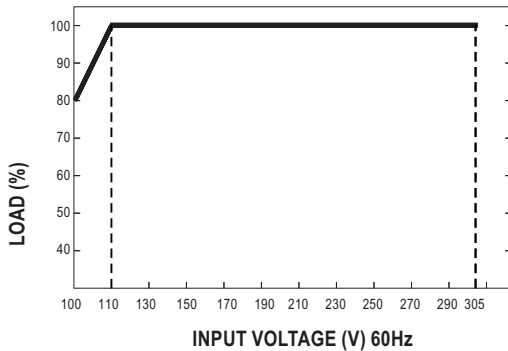

※ De-rating is needed under low input voltage.

LIFE TIME

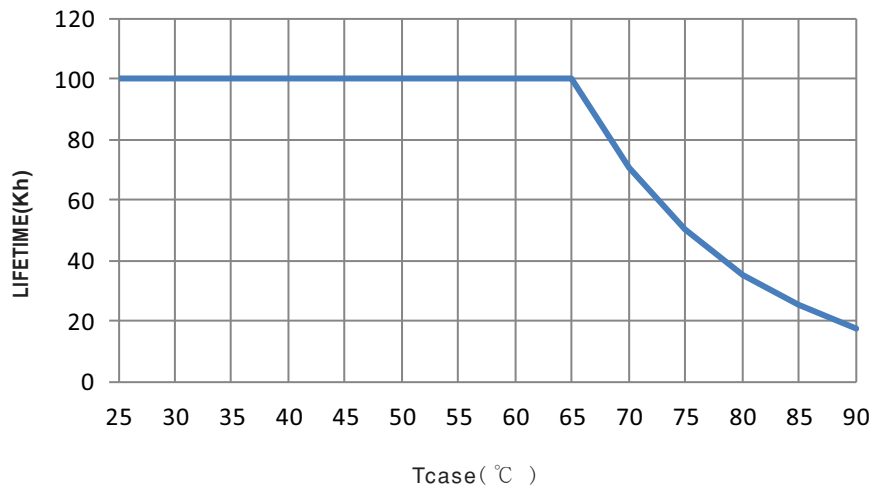

XLC-60-KN Series

60W Multiple-Stage Constant Power LED Driver



TOTAL HARMONIC DISTORTION (THD)

※ XLC-60-H-KN Model, Tcase at 75°C

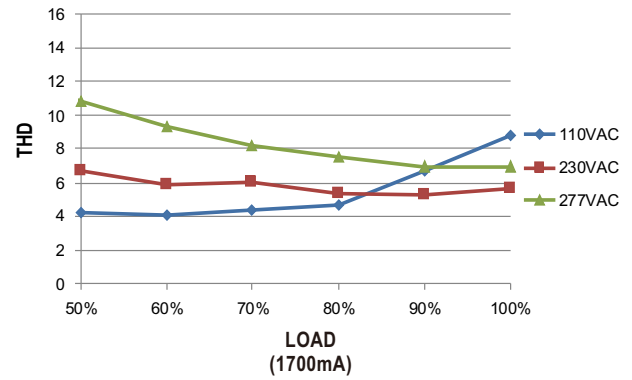
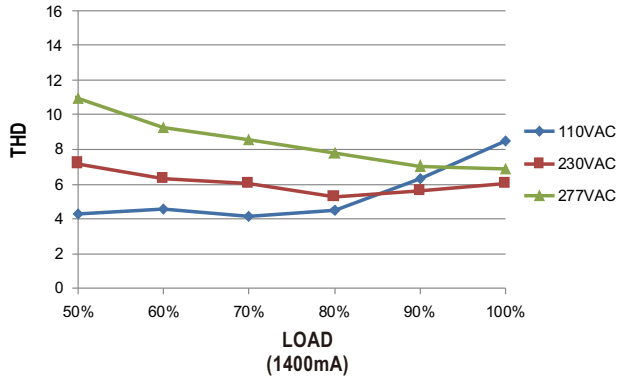

POWER FACTOR (PF) CHARACTERISTIC

※ XLC-60-H-KN Model, Tcase at 75°C

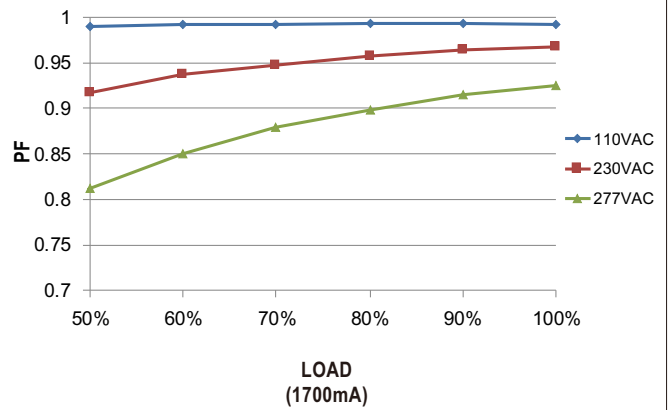
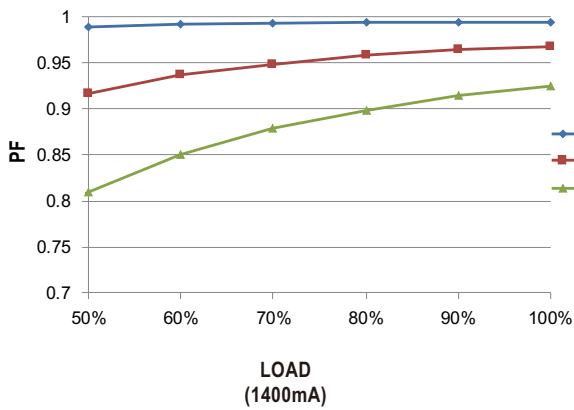

EFFICIENCY vs LOAD

XLC-60-KN series possess superior working efficiency that up to 90% can be reached in field applications.

※ XLC-60-H-KN Model, Tcase at 75°C

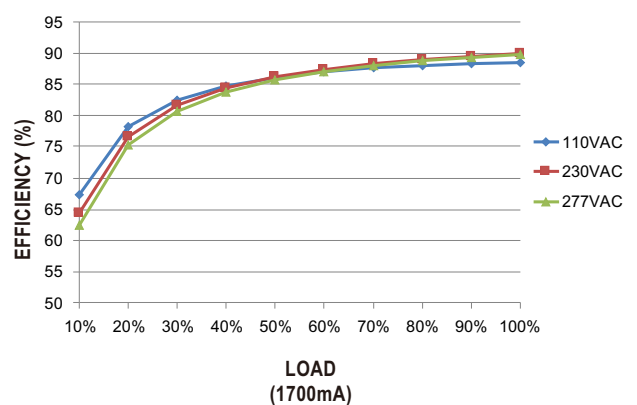
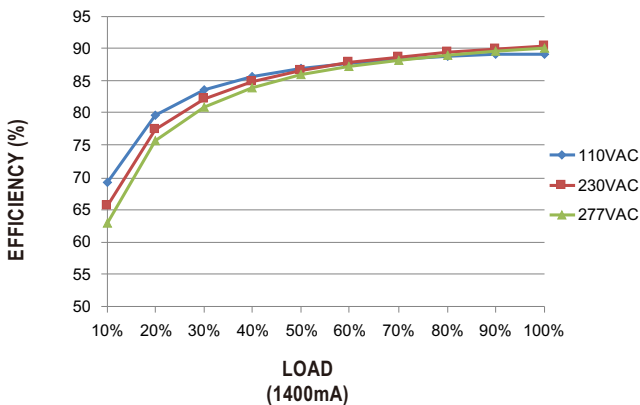

XLC-60-KN Series

60W Multiple-Stage Constant Power LED Driver



MECHANICAL SPECIFICATION

Case No. XLC-60 Unit:mm Tolerance:±1

※ XLC-60-KN Built-in Type

※ Terminal Pin No. Assignment (TB1)

Pin No.	Assignment
1	AC/N
2	AC/L
3	PUSH

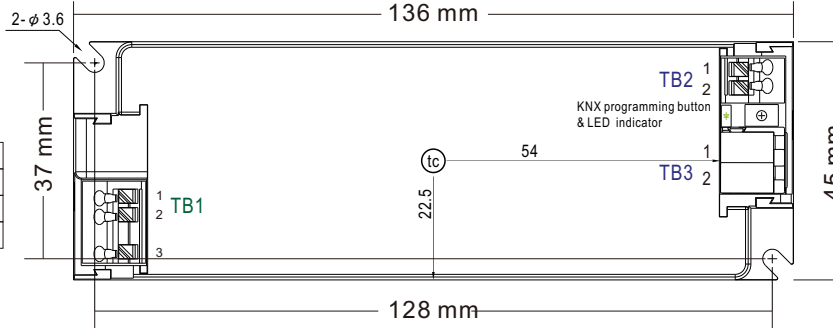

※ Terminal Pin No. Assignment (TB2)

Pin No.	Assignment
1	+V
2	-V

※ Terminal Pin No. Assignment (TB3)

Pin No.	Assignment
1	KNX+
2	KNX-

TB1 wiring:

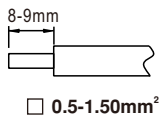

TB2 wiring:

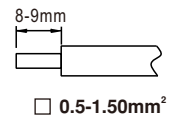

Item	Order No.	Quantity(MOQ/1Bag)
Strain-relief cap	1**3XLC-SET	50pcs (2pcs 1 set)

※ XLC-60-KNS Independent Type

Case No. XLC-60-S Unit:mm

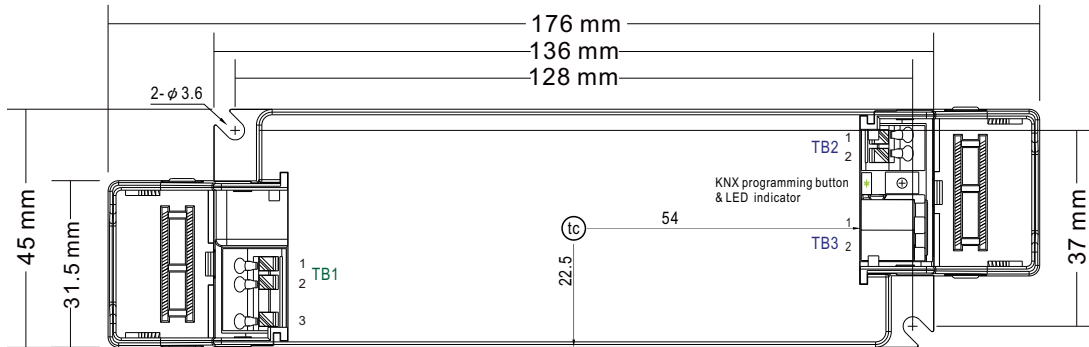

※ Terminal Pin No. Assignment (TB1)

Pin No.	Assignment
1	AC/N
2	AC/L
3	PUSH

※ Terminal Pin No. Assignment (TB2)

Pin No.	Assignment
1	+V
2	-V

※ Terminal Pin No. Assignment (TB3)

Pin No.	Assignment
1	KNX+
2	KNX-

TB1 wiring:

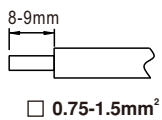

TB2 wiring:

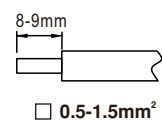

Installation Manual

Please refer to : <http://www.meanwell.com/manual.html>