

# PHP-3500 Series

3500W Conduction Cooling with PFC Switching Supply



Ordering No.: PGG1WHS-656



## Features

- Slim and Low profile (60mm)
- Fanless design, cooling by water conduction
- Built-in active PFC function
- -30~+70°C working temperature
- Built-in PMBus communication protocol, CANbus optional
- Output voltage and constant current level programmable
- Protections: Short circuit / Overload / Over voltage / Over temperature
- Built-in remote ON-OFF control
- DC OK active signal
- Optional cold plate for quick implementation
- OVC III Operating altitude up to 3000 meter (Note.9)
- LED indicator for power on
- High efficiency up to 96%
- Active current sharing up to 14000W (3+1)
- 5 years warranty

## Applications

- Industrial automation machinery
- Industrial control system
- Mechanical and electrical equipment
- Electronic instruments, equipments or apparatus
- Household appliances

## GTIN CODE

MW Search: <https://www.meanwell.com/serviceGTIN.aspx>

## Description

PHP-3500 series is a 3500W single-output slim type power supply with 60mm of low profile design. Adopting the full range 90~264VAC input, the entire series provides an output voltage line of 24V and 48V. In addition to the high efficiency up to 96%, that the whole series operates from -30°C ~ +70°C under air convection without fan. PHP-3500 has the complete protection functions and 2G anti-vibration capability; it complies with the international safety regulations such as TUV BS EN/EN62368-1, UL62368-1, and design refers to BS EN/EN61558-1 and BS EN/EN60335-1. PHP-3500 series serves as a high performance power supply solution for various industrial applications.

## Model Encoding

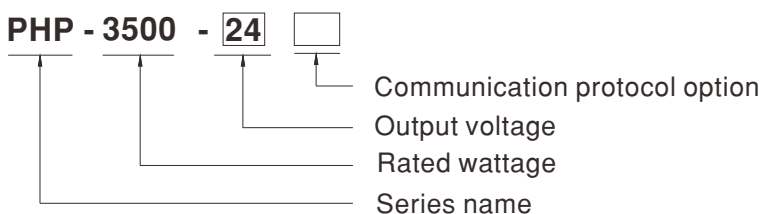

| Type  | Communication Protocol | Note       |
|-------|------------------------|------------|
| Blank | PMBus protocol         | In Stock   |
| CAN   | CANBus protocol        | By request |

### SPECIFICATION

| MODEL                          |  | PHP-3500-24   | PHP-3500-48  |   |
|--------------------------------|--|---|--|---|
| OUTPUT                         | DC VOLTAGE   | 24V   | 48V  |   |
|                                | RATED CURRENT  | 145A  | 73A  |   |
|                                | RATED POWER  | 3480W   | 3504W  |   |
|                                | RIPPLE & NOISE (max.) Note.2   | 300mVp-p  | 480mVp-p   |   |
|                                | VOLTAGE ADJ. RANGE   | By built-in potentiometer, SVR  |  |   |
|                                |  | 24~28.8V  | 48~57.6V   |   |
|                                | VOLTAGE TOLERANCE Note.3   | ±1.0%   | ±1.0%  |   |
|                                | LINE REGULATION  | ±0.5%   | ±0.5%  |   |
|                                | LOAD REGULATION  | ±0.5%   | ±0.5%  |   |
| SETUP, RISE TIME Note.4        | 1500ms, 60ms/230VAC    1500ms, 60ms/115VAC at full load  |   |  |   |
| HOLD UP TIME (Typ.) Note.4     | 16ms/230VAC at 75% load    10ms/230VAC at full load ; 16ms/115VAC at 75% load    10ms/115VAC at full load  |   |  |   |
| INPUT                          | VOLTAGE RANGE Note.4   | 90 ~ 264VAC    127 ~ 370VDC   |  |   |
|                                | FREQUENCY RANGE  | 47 ~ 63Hz   |  |   |
|                                | POWER FACTOR (Typ.) Note.4   | PF ≥ 0.95/230VAC    PF ≥ 0.99/115VAC at full load   |  |   |
|                                | EFFICIENCY (Typ.) Note.10  | 95%   | 96%  |   |
|                                | AC CURRENT (Typ.)  | 20A/115VAC    20A/230VAC  |  |   |
|                                | INRUSH CURRENT (Typ.)  | Cold start 30A/115VAC    80A/230VAC   |  |   |
|                                | LEAKAGE CURRENT  | 2mA / 240VAC  |  |   |
| PROTECTION                     | OVERLOAD   | 105 ~ 115% rated current<br>Protection type : Constant current limiting, shut down O/P voltage after 5 sec. After O/P voltage falls, re-power on to recover |  |   |
|                                | OVER VOLTAGE   | 30 ~ 36V  | 60 ~ 72V   |   |
|                                |  | Protection type : Shut down O/P voltage, re-power on to recover   |  |   |
| OVER TEMPERATURE               | Protection type : Shut down O/P voltage, recovers automatically after temperature goes down  |   |  |   |
| FUNCTION                       | OUTPUT VOLTAGE PROGRAMMABLE(PV) Note.5,6   | Adjustment of output voltage is allowable to 50 ~ 120% of nominal output voltage. Please refer to the Function Manual.                                      |  |   |
|                                | OUTPUT CURRENT PROGRAMMABLE(PC) Note.6   | Adjustment of constant current level is allowable to 20 ~ 100% of rated current. Please refer to the Function Manual.                                       |  |   |
|                                | REMOTE ON/OFF CONTROL  | Power ON : Short circuit    Power OFF : Open circuit  |  |   |
|                                | AUXILIARY POWER  | 12V@0.5A tolerance ±10%, ripple 150mVp-p  |  |   |
|                                | DC-OK SIGNAL   | The TTL signal out, PSU turn on = -0.5 ~ 0.5V ; PSU turn off = 3.5 ~ 5.5V. Please refer to the Function Manual.   |  |   |
| ENVIRONMENT                    | WORKING TEMP.  | -30 ~ +70°C Baseplate temperature (Refer to "Derating Curve")   |  |   |
|                                | WORKING HUMIDITY   | 20 ~ 90% RH non-condensing  |  |   |
|                                | STORAGE TEMP., HUMIDITY  | -40 ~ +85°C, 10 ~ 95% RH non-condensing   |  |   |
|                                | TEMP. COEFFICIENT  | ±0.03%/°C (0 ~ 50°C)  |  |   |
|                                | VIBRATION  | 10 ~ 500Hz, 2G 10min./1cycle, 60min. each along X, Y, Z axes  |  |   |
|                                | OVER VOLTAGE CATEGORY  | II ; According to EN61558; altitude up to 5000 meters.  |  |   |
| SAFETY & EMC (Note.8)          | SAFETY STANDARDS   | UL62368-1, CAN/CSA C22.2 No. 62368-1, TUV BS EN/EN62368-1, EAC TP TC 004 approved ; design refers to BS EN/EN61558-1, BS EN/EN60335-1                       |  |   |
|                                | WITHSTAND VOLTAGE  | I/P-O/P:3KVAC    I/P-FG:2KVAC    O/P-FG:1.25KVAC  |  |   |
|                                | ISOLATION RESISTANCE   | I/P-O/P, I/P-FG, O/P-FG:100M Ohms/500VDC/25°C / 70%RH   |  |   |
|                                | EMC EMISSION   | Parameter   | Standard   | Test Level / Note                       |
|                                |  | Conducted   | BS EN/EN55032 (CISPR32)  | Class A                                 |
|                                |  | Radiated  | BS EN/EN55032 (CISPR32)  | Class A                                 |
|                                |  | Harmonic Current  | BS EN/EN61000-3-12   | -----                                   |
|                                | Voltage Flicker  | BS EN/EN61000-3-3   | -----  |   |
|                                | EMC IMMUNITY   | Parameter   | Standard   | Test Level / Note                       |
|                                |  | ESD   | BS EN/EN61000-4-2  | Level 3, 8KV air ; Level 2, 4KV contact |
| Radiated                       |  | BS EN/EN61000-4-3   | Level 3  |   |
| EFT / Burst                    |  | BS EN/EN61000-4-4   | Level 3  |   |
| Surge                          |  | BS EN/EN61000-6-2   | 2KV/Line-Line 4KV/Line-Earth   |   |
| Conducted                      |  | BS EN/EN61000-4-6   | Level 3  |   |
| Magnetic Field                 |  | BS EN/EN61000-4-8   | Level 4  |   |
| Voltage Dips and Interruptions |  | BS EN/EN61000-4-11  | >95% dip 0.5 periods, 30% dip 25 periods, >95% interruptions 250 periods |   |
| OTHERS                         | MTBF   | 544.8K hrs min.    Telcordia SR-332 (Bellcore) ; 56.3K hrs min.    MIL-HDBK-217F (25°C)   |  |   |
|                                | DIMENSION  | 380*141.4*60mm (L*W*H)  |  |   |
|                                | PACKING  | 4.5Kg;4pcs/19Kg/2.46CUFT  |  |   |
| NOTE                           | <p>1. All parameters NOT specially mentioned are measured at 230VAC input, rated load and 25°C of ambient temperature.</p> <p>2. Ripple &amp; noise are measured at 20MHz of bandwidth by using a 12" twisted pair-wire terminated with a 0.1uf &amp; 47uf parallel capacitor.</p> <p>3. Tolerance :includes set up tolerance, line regulation and load regulation.</p> <p>4. Derating may be needed under low input voltages. Please check the derating curve and Static characteristics for more details.</p> <p>5. Without water or fan cooling to provide adequate heat dissipation, OTP might be triggered if trimming output voltage by PV signal toward upper or bottom limits of nominal voltage. Under such condition, enhanced cooling on PSU is highly recommended.</p> <p>6. PV/PC function when users are not operating on PMBus. SVR functions when users are neither operation on PMBus nor using PV/PC.</p> <p>7. Output will shut down after O/P voltage is below &lt; 80% of Vset for 5 sec, re-power on to recover.</p> <p>8. The power supply is considered a component which will be installed into a final equipment. All the EMC tests are been executed by mounting the unit on a 600mm*900mm metal plate with 1mm of thickness. The final equipment must be re-confirmed that it still meets EMC directives. For guidance on how to perform these EMC tests, please refer to "EMI testing of component power supplies."<br/>(as available on <a href="https://www.meanwell.com/Upload/PDF/EMI_statement_en.pdf">https://www.meanwell.com/Upload/PDF/EMI_statement_en.pdf</a>)</p> <p>9. The ambient temperature derating of 3.5°C/1000m with fanless models and of 5°C/1000m with fan models for operating altitude higher than 2000m(6500ft).</p> <p>10. The efficiency is measured at 75% load.</p> <p>※ Product Liability Disclaimer : For detailed information, please refer to <a href="https://www.meanwell.com/serviceDisclaimer.aspx">https://www.meanwell.com/serviceDisclaimer.aspx</a></p> |   |  |   |

# PHP-3500 Series

3500W Conduction Cooling with PFC Switching Supply



PFC fosc : 110KHz  
PWM fosc : 100KHz

## BLOCK DIAGRAM

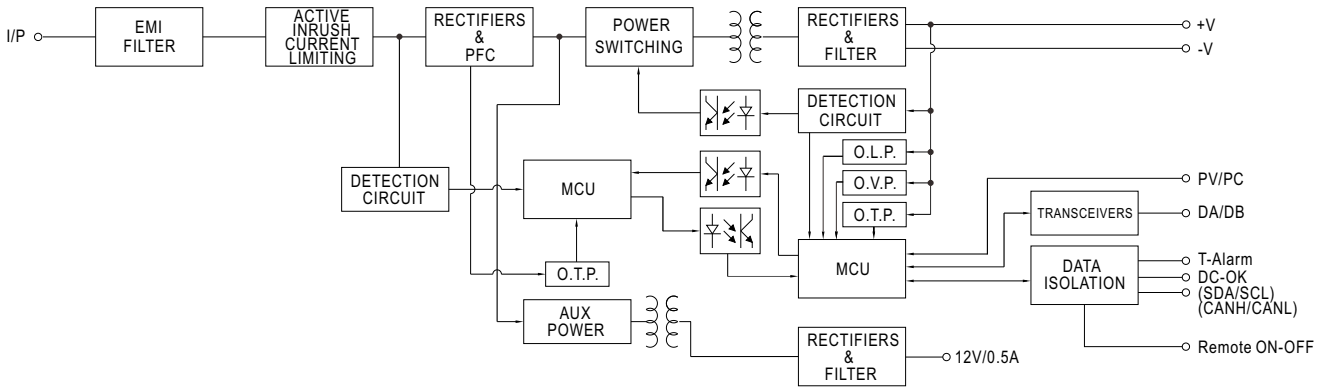

## DERATING CURVE

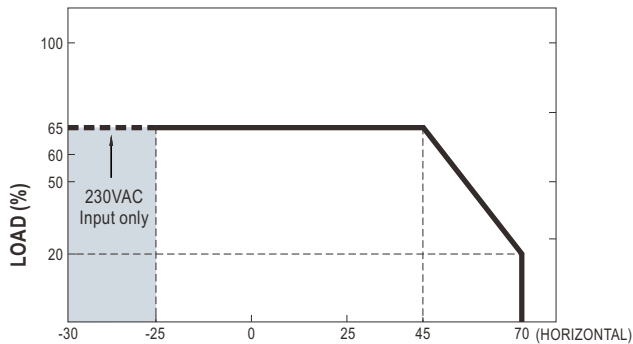

AMBIENT TEMPERATURE WITH ADDITIONAL ALUMINUM PLATE(°C)  
(450x450x3mm)

Note. Tcase max. ≤ 70°C and ambient temp must be within above de-rating curve.

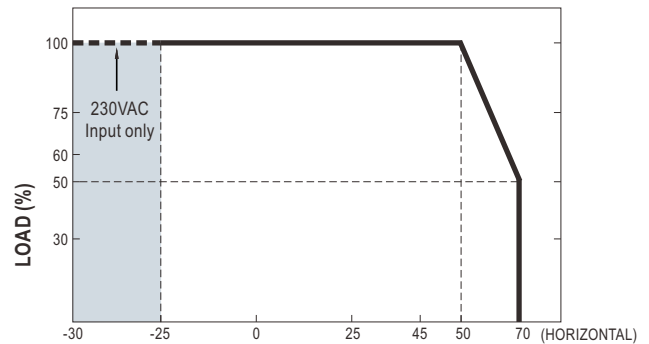

AMBIENT TEMPERATURE WITH 128 CFM FAN\*2 OR WATER COOLING SYSTEM (°C)

Note. Tcase max. ≤ 45°C and ambient temp must be within above de-rating curve.

## STATIC CHARACTERISTICS

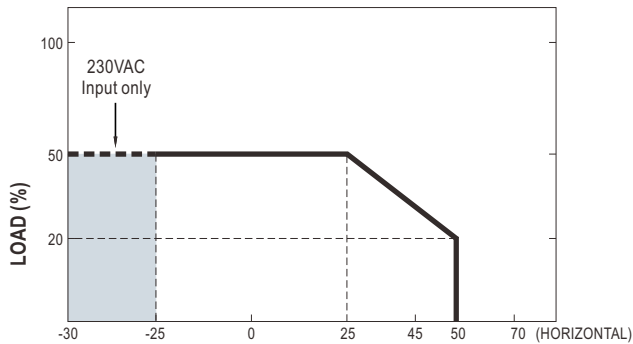

AMBIENT TEMPERATURE WITHOUT ALUMINUM PLATE(°C)

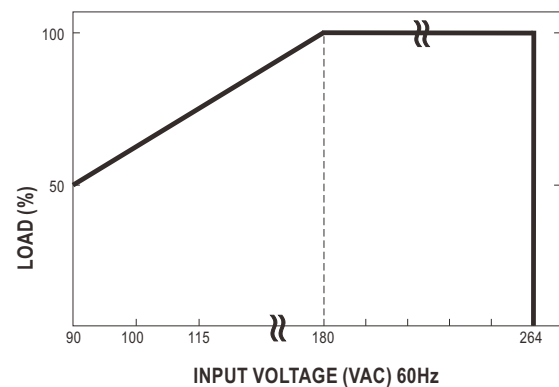

INPUT VOLTAGE (VAC) 60Hz

File Name:PHP-3500-SPEC 2024-11-28

## FUNCTION MANUAL

### 1. Output Voltage Programming (or, PV / remote voltage programming / remote adjust / margin programming / dynamic voltage trim)

※ In addition to the adjustment via the built-in potentiometer, the output voltage can be trimmed by applying EXTERNAL VOLTAGE.

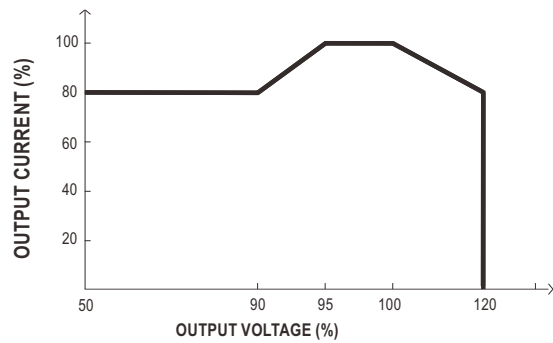
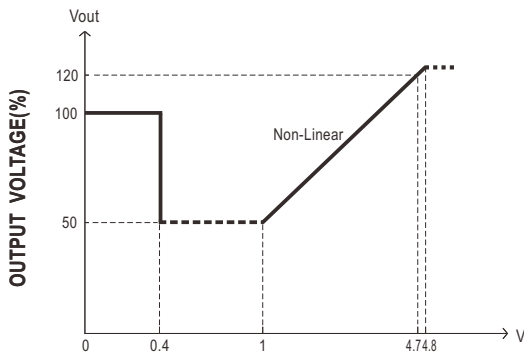
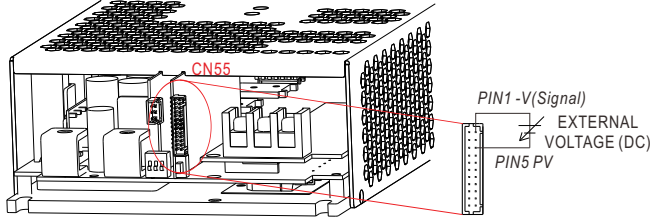

◎ The rated current should change with the Output Voltage Programming accordingly.

### 2. Output Current Programming (or, PC / remote current programming / dynamic current trim)

※ The output current can be trimmed to 20~100% of the rated current by applying EXTERNAL VOLTAGE.

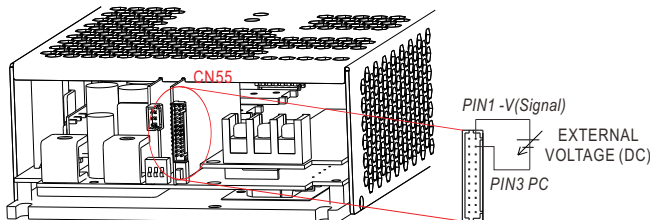

◎ Output will shut down after O/P voltage is below < 80% of Vset for 5 sec, re-power on to recover.

※ Covered by over temperature protection, auto de-rating function works under operation either in PC mode or under control by communication protocol.

T<sub>1</sub>(Typ.): Maximum ambient temperature of full load.

T<sub>2</sub>(Typ.): T<sub>1</sub>+5°C.

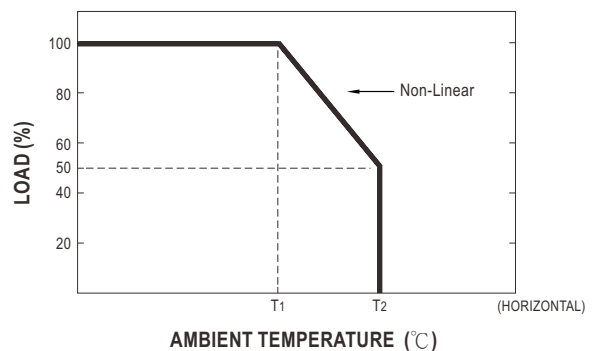
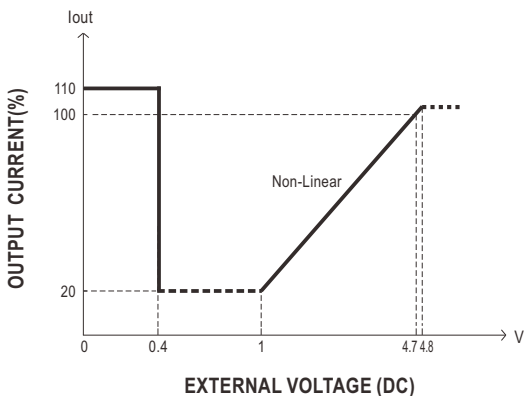

### 3. Remote ON-OFF Control

The power supply can be turned ON/OFF individually or along with other units in parallel by using the "Remote ON-OFF" function.

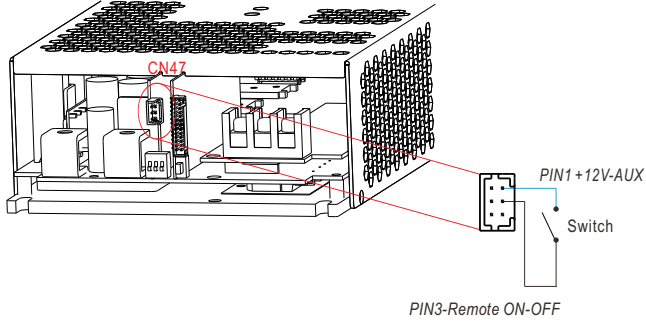

| Remote ON-OFF | Power Supply Status |
|---------------|---------------------|
| Short circuit | ON                  |
| Open circuit  | OFF                 |

### 4. DC-OK Signal

DC-OK signal is a TTL level signal. The maximum sourcing current is 10mA and the maximum external voltage is 5.6V.

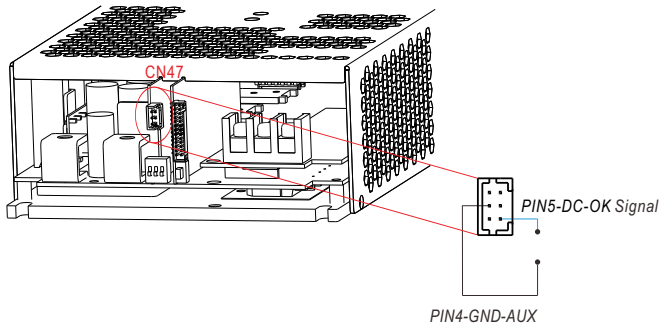

| DC-OK signal     | Power Supply Status |
|------------------|---------------------|
| "High" >3.5~5.5V | DC OK               |
| "Low" <-0.5~0.5V | Abnormal DC         |

### 5. PMBus Communication Interface

PHP-3500 supports PMBus Rev. 1.1 with maximum 100KHz bus speed, allowing information reading, status monitoring, output trimming, etc. For details, please refer to the Function Manual.

### 6. Current Sharing

PHP-3500 has the built-in active current sharing function and can be connected in parallel, up to 4 units, to provide higher output power as exhibited below :

- ※ The power supplies should be paralleled using short and large diameter wiring and then connected to the load.
- ※ Difference of output voltages among parallel units should be less than 0.2V.
- ※ The total output current must not exceed the value determined by the following equation:  

$$\text{Maximum output current at parallel operation} = (\text{Rated current per unit}) \times (\text{Number of unit}) \times 0.9$$
- ※ When the total output current is less than 5% of the total rated current, or say  $(5\% \text{ of Rated current per unit}) \times (\text{Number of unit})$  the current shared among units may not be balanced.
- ※ Under parallel operation ripple of the output voltage may be higher than the SPEC at light load condition. It will go back to normal ripple level once the output load is more than 5%.
- ※ CN55/SW51 Function pin connection

| Parallel | PSU1 |      | PSU2 |      | PSU3 |      | PSU4 |      |
|----------|------|------|------|------|------|------|------|------|
|          | CN55 | SW51 | CN55 | SW51 | CN55 | SW51 | CN55 | SW51 |
| 1 unit   | X    | ON   | —    | —    | —    | —    | —    | —    |
| 2 unit   | V    | ON   | V    | ON   | —    | —    | —    | —    |
| 3 unit   | V    | ON   | V    | OFF  | V    | ON   | —    | —    |
| 4 unit   | V    | ON   | V    | OFF  | V    | OFF  | V    | ON   |

(V : CN55 connected ; X : CN55 not connected.)

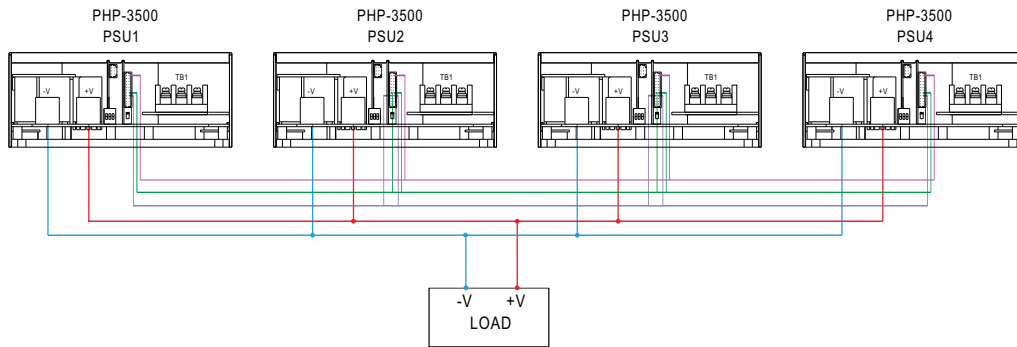
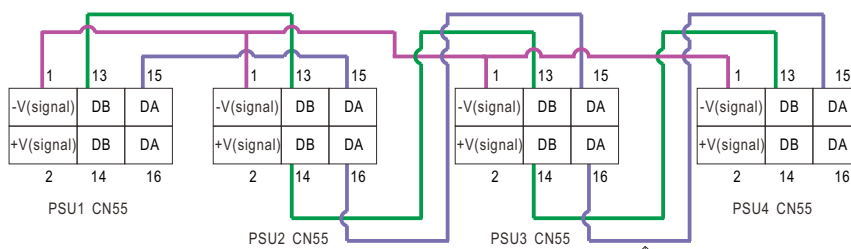

Fig 6.1



If the lines of CN55 are too long, they should be twisted in pairs to avoid the noise.

◎ DA, DB and -V(signal) are connected mutually in parallel.

# PHP-3500 Series

3500W Conduction Cooling with PFC Switching Supply



## MECHANICAL SPECIFICATION

(Unit: mm, tolerance ±0.5mm)

Case No.278A

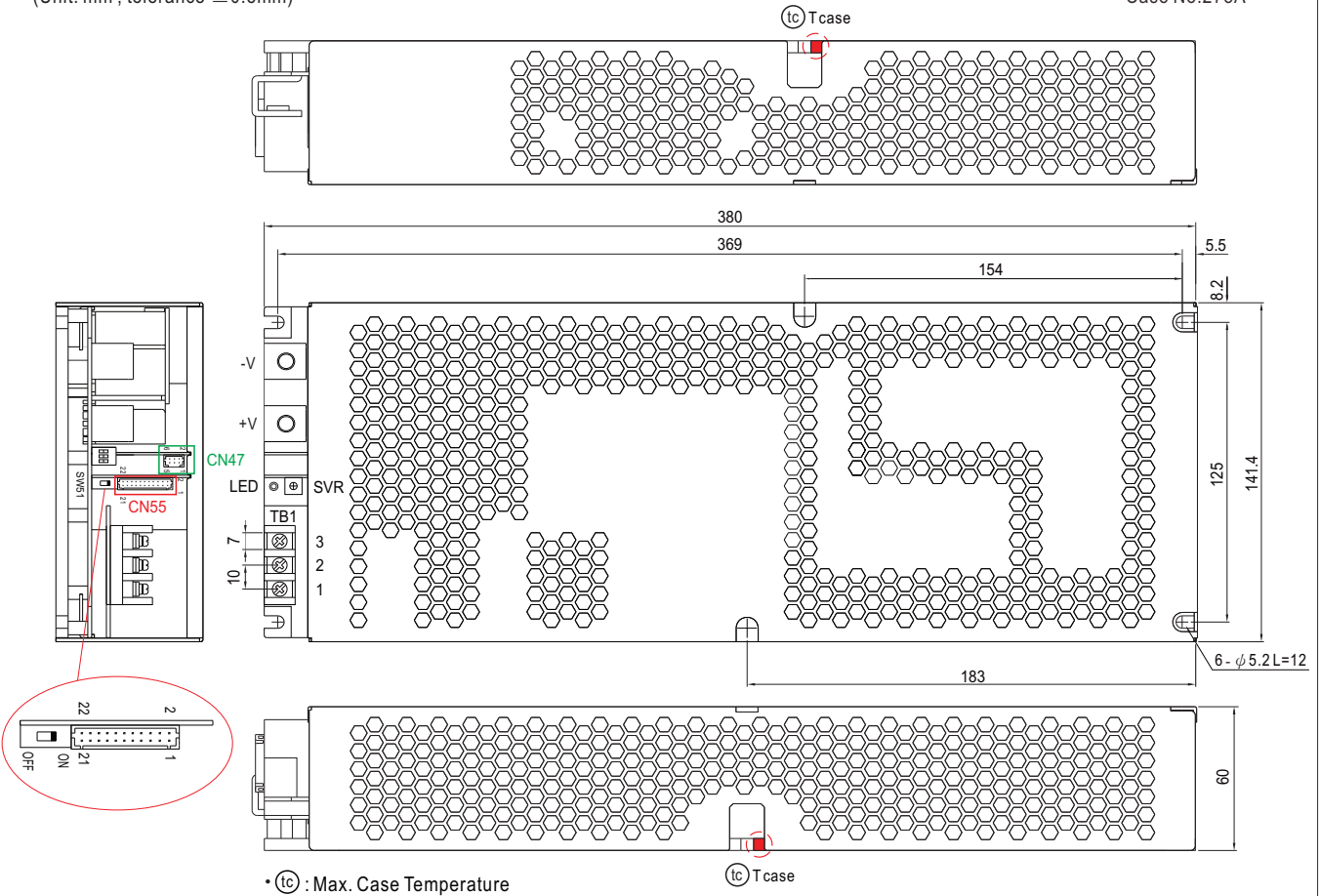

• (tc) : Max. Case Temperature

(tc) Tcase

### AC Input Terminal(TB1) Pin NO. Assignment

| Pin No. | Assignment | Terminal            | Max mounting torque |
|---------|------------|---------------------|---------------------|
| 1       | AC/L       | DECA<br>T25-EM10-03 | 18Kgf-cm            |
| 2       | AC/N       |                     |                     |
| 3       | ⊥          |                     |                     |

### ※DC Output Terminal Pin No. Assignment

| Assignment | Diagram | Maximum mounting torque |
|------------|---------|-------------------------|
| +V, -V     |         | 10Kgf-cm                |

### ※ LED Status Indicators

| LED   | Description   |
|---|---|
| <span style="color: green;">●</span> Green        | The power supply functions normally.  |
| <span style="color: red;">●</span> Red (Flashing) | The LED will flash with red light when internal temperature reaches 85°C; under this condition, the unit still operates normally without entering OTP. (In the meantime, an alarm signal will be sent out through the PMBus /CANBus interface.) |
| <span style="color: red;">●</span> Red            | Abnormal status (Over temperature protection, Overload protection)  |

### ※Control Pin No. Assignment(CN55) : HRS DF11-22DP-2DS or equivalent

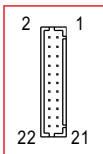

|                |                             |
|----------------|-----------------------------|
| Mating Housing | HRS DF11-22DS or equivalent |
| Terminal       | HRS DF11-22SC or equivalent |

| Pin No.        | Function    | Description   |
|----------------|-------------|---|
| 1              | -V (Signal) | Negative output voltage signal.                                     |
| 2              | +V (Signal) | Positive output voltage signal.                                     |
| 3,4            | PC          | Connection for constant current level programming. (Note.1)         |
| 5,6            | PV          | Connection for output voltage programming. (Note.1)                 |
| 7,8,9,10,11,12 | NC          | ----  |
| 13,14,15,16    | DB,DA       | Differential digital signal for parallel control. (Note.1)          |
| 17,18          | GND-AUX(S)  | The signal return is isolated from the output terminals (+V & -V).  |
| 19,20          | SCL         | For PMBus model: Serial Clock used in the PMBus interface. (Note.2) |
|                | CANL        | For CANBus model: Data line used in CANBus interface. (Note.2)      |
| 21,22          | SDA         | For PMBus model: Serial Data used in the PMBus interface. (Note.2)  |
|                | CANH        | For CANBus model: Data line used in CANBus interface. (Note.2)      |

Note1: Non-isolated signal, referenced to [-V(signal)].

Note2: Isolated signal, referenced to GND-AUX(S).

# PHP-3500 Series

3500W Conduction Cooling with PFC Switching Supply



※Control Pin No. Assignment(CN47) : HRS DF11-06DP-2DS or equivalent

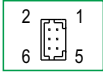

|                |                             |
|----------------|-----------------------------|
| Mating Housing | HRS DF11-06DS or equivalent |
| Terminal       | HRS DF11-**SC or equivalent |

| Pin No. | Function      | Description  |
|---------|---------------|--|
| 1       | +12V-AUX      | Auxiliary voltage output, 10.8~13.2V, referenced to GND-AUX (pin 2). The maximum load current is 0.5A. This output has the built-in "Oring diodes" and is not controlled by the Remote ON/OFF control.   |
| 2       | GND-AUX       | Auxiliary voltage output GND. The signal return is isolated from the output terminals (+V & -V).   |
| 3       | Remote ON-OFF | The unit can turn the output ON/OFF by electrical signal or dry contact between Remote ON/OFF and +12V-AUX. (Note.2)<br>Short (10.8 ~ 13.2V) : Power ON ; Open (-0.5 ~ 0.5V) : Power OFF ; The maximum input voltage is 13.2V.                             |
| 4       | GND-AUX(S)    | The signal return is isolated from the output terminals (+V & -V).   |
| 5       | DC-OK         | High (3.5 ~ 5.5V) : When the Vout $\leq$ 80% $\pm$ 5%.<br>Low (-0.5 ~ 0.5V) : When Vout $\geq$ 80% $\pm$ 5%.<br>The maximum sourcing current is 10mA and only for output. (Note.2)   |
| 6       | T-ALARM       | High (3.5 ~ 5.5V) : When the internal temperature exceeds the limit of temperature alarm.<br>Low (-0.5 ~ 0.5V) : When the internal temperature is normal, and when fan works normally.<br>The maximum sourcing current is 10mA and only for output(Note.2) |

## 1. Operate with additional aluminum plate

In order to meet the "Derating Curve" and the "Static Characteristics", PHP-3500 series must be installed onto an aluminum plate (or the cabinet of the same size) on the bottom. The size of the suggested aluminum plate is shown as below. And for optimizing thermal performance, the aluminum plate must have an even and smooth surface (or coated with thermal grease), and PHP-3500 series must be firmly mounted at the center of the aluminum plate.

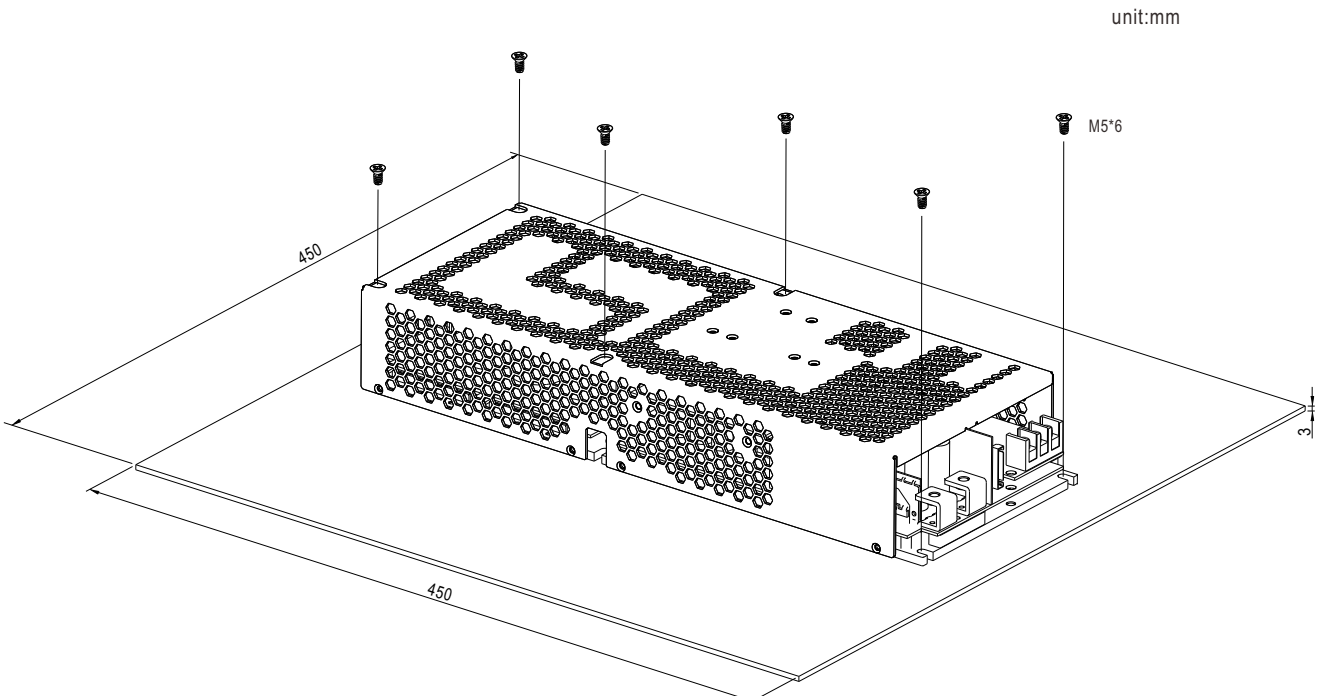

File Name:PHP-3500-SPEC 2024-11-28

# PHP-3500 Series

3500W Conduction Cooling with PFC Switching Supply



## 2. Suitable for conduction cooling

Inlet temperature: 25°C

Flow rate (minimum): 1 LPM

If optional cold plate is in need, please contact MEAN WELL for details.

Ordering No.: PGG1WHS-656

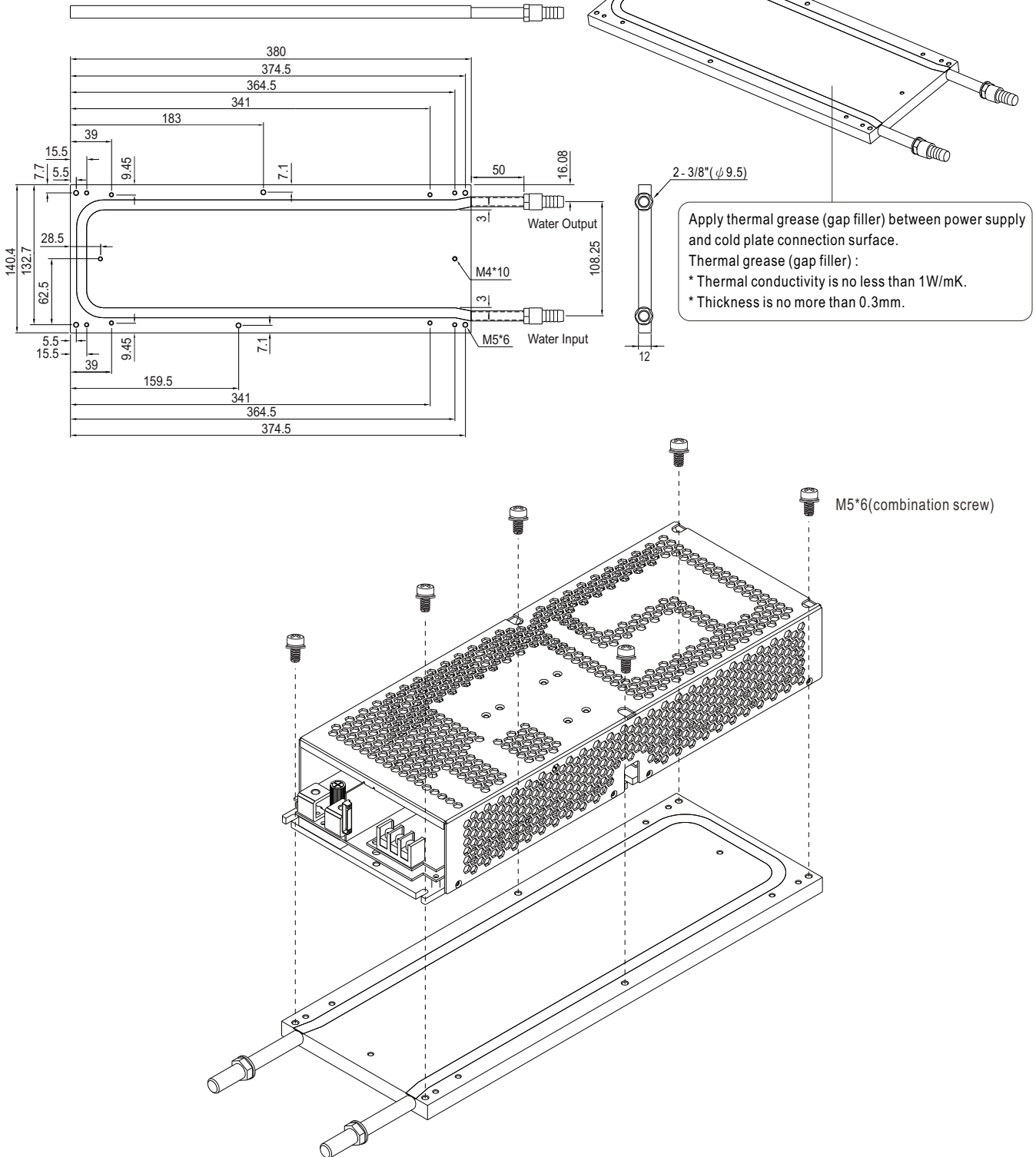

File Name:PHP-3500-SPEC 2024-11-28

# PHP-3500 Series

3500W Conduction Cooling with PFC Switching Supply



### 3. With 128CFM FAN x 2

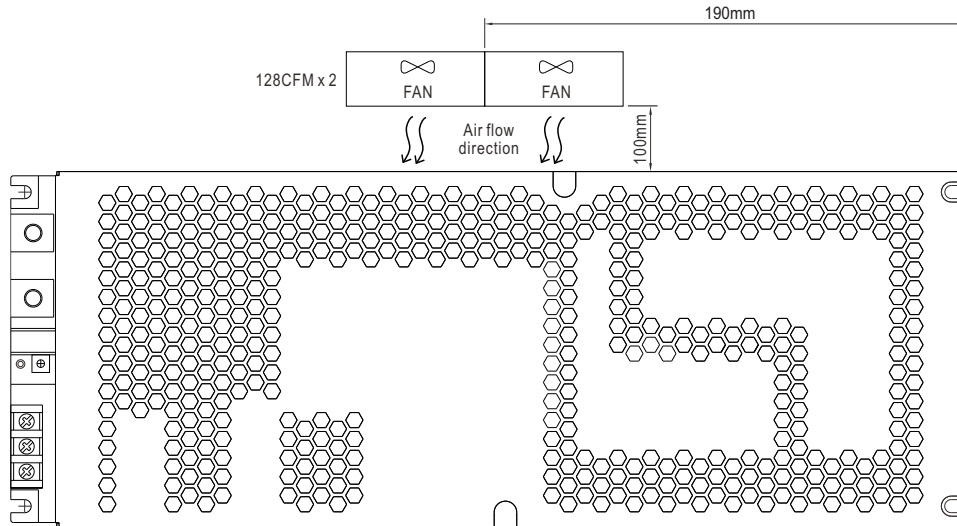

### 4. Condensation - Safe operating area.

