

Input: Single-phase 115 – 277 Vac
Output Load: power supply 12 Vdc; 3 A
Output Battery: charging 12 Vdc; 3 A
 Suited for the following battery types: Open Lead Acid, Sealed Lead Acid, Lead Gel, Li-Ion and Ni-Cd
 Automatic diagnostic of battery status. Charging curve IUoU, constant voltage and constant current Battery Life Test function (Battery Care)
 Switching technology, output voltage 10-14.4Vdc Three charging levels: Boost, Float and Recovery
 Protected against short circuit and inverted polarity
 Signal output (contact free) for discharged or damaged battery
 Signal output (contact free) for mains or Back-Up
 Protection degree IP20 - DIN rail; Space saving

Technical features

Thanks to the All In One units (DC-UPS), it will be possible to optimize power management. The available power is automatically allocated between load and battery, supplying power to the load is the first priority of the unit thus it is not necessary to double the power, because also the power going to the battery will go to the load if the load so requires. The maximum available current on the load output is 2 times the value of the device rated current I_n . We call "Battery Care" the concept base on algorithms that implement rapid and automatic charging, battery charge optimization during time, flat batteries recovery and real time diagnostic during installation and operation. The Real Time Auto-diagnostic system, monitoring battery faults such as, battery Sulfated, elements in short circuit, accidental reverse polarity connection, disconnection of the battery, they can easily be detected and removed by help of Blink Code of Diagnosis Led; during the installation and after sell. The continuous monitoring of battery efficiency reduces battery damage risk and allows a safe operation in permanent connection. Each device is suited for all battery types by means of jumpers it is possible setting predefined curves for Open Lead Acid, Sealed Lead Acid, Gel, Ni-Cd (option). They are programmed for two charging levels, boost and charge, but they can be changed to single charging level by the user. A rugged casing with bracket for DIN rail mounting provides IP20 protection degree. They are extremely compact and cost-effective.

De Rating $T^a > 50^\circ\text{C}$	- 2.5%(I_n) / $^\circ\text{C}$
Ambient temperature Storage	-40 ÷ +85 $^\circ\text{C}$
Humidity at 25 $^\circ\text{C}$ no condensation	95% to 25 $^\circ\text{C}$
Altitude: 0 to 2 000m - 0 to 6 560ft	No restrictions
Altitude: 2 000 to 6 000m - 6 560 to 20 000ft	De-rating 5 $^\circ\text{C}/1000\text{m}$
Cooling	Auto convention

General Data

Insulation voltage (IN/OUT)	3000 Vac
Insulation voltage (Input / Earth, PE)	2000 Vac
Insulation voltage (Out Load & Battery / Earth, PE)	500 Vac
Insulation voltage (Out Load & Battery / Fault System & Main or Back Up terminal)	500 Vac
Protection Class (EN/IEC 60529)	IP20
Reliability: MTBF IEC 61709	> 300.000 h
Pollution Degree Environment	2
Connection Terminal Blocks screw Type	2,5mm(24–14AWG)
Protection class (PE Connected)	I, with PE
Dimensions (w-h-d)	65x115x135 mm
Weight	0.6 kg approx.

Input Data

Nominal Input Voltage Vac	115 – 230– 277
Voltage range Vac	90 ÷ 305
Inrush Current ($V_n - I_n$ nom. Load) I^2t	$\leq 11 \text{ A} \leq 5 \text{ msec.}$
Frequency	47 ÷ 63 Hz
Input Current (115 – 230 – 277 Vac) Max	2.8- 1.5 - 1.38 A
Internal fuse (not replaceable)	4 A
External Fuse (recommended) MCB curve B	10 A

Output Data (internal power supply)

Output Voltage (V_n) / Nominal Current (I_n)	12 Vdc / 3A
Output Current $I_n = I_{load}$	3 A
Efficiency (at 50% of rated current)	$\geq 90 \%$
Ripple and Noise (20 MHz Bandwidth)	80 mV $_{pp}$ (max)
Turn-On delay after applying mains voltage	1 sec. (max)
Start up with Strong Load (capacitive load)	Yes, Unlimited
Dissipation power load max (W)	15
Current Short Circuit I_{cc} . Max 2 sec.: Hiccup mode 60 $^\circ\text{C}$. Restart automatically.	$I_n \times 3.5$
Over Load protection	Yes
Over Voltage Output protection	Yes (typ. 35 Vdc)
Overheating Thermal protection	Yes

Battery Output

Output Voltage Battery	Follow the Out Load
Boost-Fast charge Jumper	Lead Acid: 2.4
Configuration 25 $^\circ\text{C}$ (V/cell). Jumper	NiCd:1.51; Li-ion: 3.65
Configuration battery type	

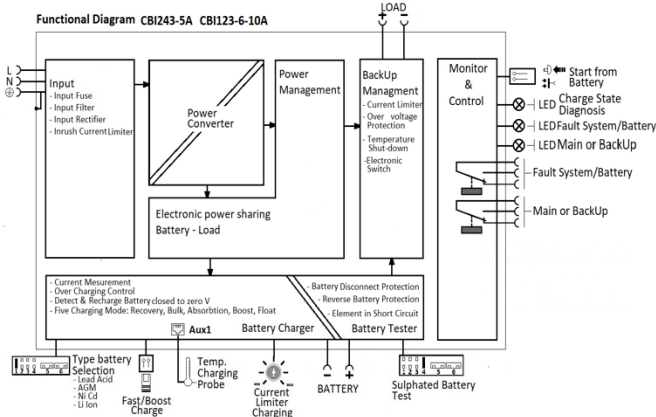

Norms and Certifications

In Conformity to: e_{NEC} EN60950 / UL60950-1 and CSA C22.2 No. 60950-1-07 (Information Technology Equipment) – Safety – Part1: General Requirement. Electrical safety; Electrical safety: EN54-4 and EN12101-10; 89/336/EEC EMC Directive; 2014/35/UE (Low Voltage); Safety EN IEC 62368-1: 2014/AC:2015; DIN41773 (Charging cycle); Emission: IEC 61000-6-3; Immunity: IEC 61000-6-2. CE.

Climatic Data

Ambient temperature (operation)	-25 ÷ +70 $^\circ\text{C}$
---------------------------------	----------------------------

¹Can be adjusted via PC software mode

All specifications are subject to change without notice
 CBI123A Data sheet _R37.docx

Float Charge Jumper Configuration 25°C (V/cell)	Lead Acid: 2.23; 2.25;2.27;2.3
Jumper Configuration battery type	NiCd:1.4; Li-ion: 3.45
Max.Time Boost–Bulk charge (Typ. at IN)	15 h
Min.Time Boost–Bulk charge (Typ. at IN)	1 min.
Recovery Charge	2 – 10 Vdc
Charging current max I_{batt}	3 A \pm 5%
Charging current limiting I_{adj}	20 \div 100 % / I_{bat}
Reverse battery protection	Yes
Sulfated battery check	Yes by Jumper
Short circuit Element Detection	Yes
Detection of element in short circuit	Yes
Quiescent Current max.	\leq 100 mA
Charging Curve automatic: IUoU	4 stage
Remote Input Control (RTCONN cable)	Boost / Float
Load Output	
Output voltage Vdc (at I_n)	10 - 14.4 V (17 Ni-Cd)
Nominal current I_{load}	1.1 x I_n A \pm 5%
Continuous current (Without battery) $I_{load= I_n}$	3 A
Continuous current (With battery) $I_{load= I_n + I_{batt}}$	6 A
Max. current Output Load (Main) $I_{load = I_n + I_{batt}}$ (4 sec.)	12 A max.
Max. current Output Load (Back Up) $I_{load = I_n + I_{batt}}$ (4 sec.)	6 A max.
Start From Battery Without Main (Remote Input Control)	RTCONN (cable) Push Button
Time Buffering; min (switch output off without main input)	∞: standard 5 min.: Require SW
Threshold alarm Battery almost flat	11.5 – 12 Vdc batt
LVD. (Protections against total Battery discharge)	10 – 11 Vdc batt
Signal Output (free switch contacts)	
Main or Backup Input Power	Yes
Low Battery	Yes
Fault Battery or system	Yes
Type of Signal Output Contact	
Dry Contact. Current can be switched (EN60947.4.1): Max: DC1: 30 Vdc 1 A; AC1: 60 Vac 1A (Resistive load) Min: 1mA at 5 Vdc (Min permissive load)	
Fault System / Low Battery	C NC NO
Main or Back Up	C NC NO
Signal Input / Output (RJ45)	
Temp. Comp. Battery (with external probe): Aux Out	RJ Temp (cable)
Remote monitoring LED from Front Device: Aux Out	RJ 45 (cable)
Accessory	
RTCONN	Cable Start from battery Length 1m. Jumper 6
RJTEMP451	Temperature Probe Length 1m.
RJTEMP453	Temperature Probe Length 3m.
RJ45COUPLER	RJ45 Three way "Daisy Chain" for Aux 2
DPY353	Display for: Monitoring the Battery state, Battery Charging Section.

¹Can be adjusted via PC software mode

All specifications are subject to change without notice
CBI123A Data sheet _R37.docx

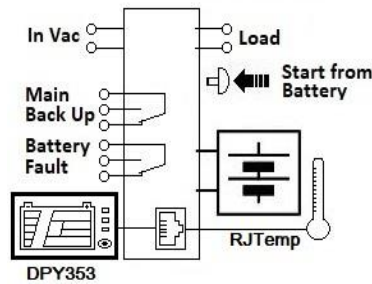

Input: Single-phase 115 – 277 Vac
Output Load: power supply 12 Vdc; 6 A
Output Battery: charging 12 Vdc; 6 A
 Suited for the following battery types: Open Lead Acid, Sealed Lead Acid, Lead Gel, Li-Ion and Ni-Cd
 Automatic diagnostic of battery status. Charging curve IUoU, constant voltage and constant current Battery Life Test function (Battery Care)
 Switching technology, output voltage 10-14.4Vdc Three charging levels: Boost, Float and Recovery
 Protected against short circuit and inverted polarity
 Signal output (contact free) for discharged or damaged battery
 Signal output (contact free) for mains or Back-UP
 Protection degree IP20 - DIN rail; Space saving

Technical features

Thanks to the All In One units (DC-UPS), it will be possible to optimize power management. The available power is automatically allocated between load and battery, supplying power to the load is the first priority of the unit thus it is not necessary to double the power, because also the power going to the battery will go to the load if the load so requires. The maximum available current on the load output is 2 times the value of the device rated current I_n . We call "Battery Care" the concept base on algorithms that implement rapid and automatic charging, battery charge optimization during time, flat batteries recovery and real time diagnostic during installation and operation. The Real Time Auto-diagnostic system, monitoring battery faults such as, battery Sulfated, elements in short circuit, accidental reverse polarity connection, disconnection of the battery, they can easily be detected and removed by help of Blink Code of Diagnosis Led; during the installation and after sell. The continuous monitoring of battery efficiency reduces battery damage risk and allows a safe operation in permanent connection. Each device is suited for all battery types by means of jumpers it is possible setting predefined curves for Open Lead Acid, Sealed Lead Acid, Gel, Ni-Cd (option). They are programmed for two charging levels, boost and charge, but they can be changed to single charging level by the user. A rugged casing with bracket for DIN rail mounting provides IP20 protection degree. They are extremely compact and cost-effective.

Ambient temperature Storage	-40 ÷ +85°C
Humidity at 25 °C no condensation	95% to 25°C
Altitude: 0 to 2 000m - 0 to 5 560ft	No restrictions
Altitude: 2 000 to 6 000m - 6 560 to 20 000ft	De-rating 5°C/1000m
Cooling	Auto convection

General Data

Insulation voltage (IN/OUT)	3000 Vac
Insulation voltage (Input / Earth, PE)	2000 Vac
Insulation voltage (Out Load & Battery / Earth, PE)	500 Vac
Insulation voltage (Out Load & Battery / Fault System & Main or Back Up terminal)	500 Vac
Protection Class (EN/IEC 60529)	IP20
Reliability: MTBF IEC 61709	> 300.000 h
Pollution Degree Environment	2
Connection Terminal Blocks screw Type	2,5mm(24–14AWG)

Protection class (PE Connected)	I, with PE
Dimensions (w-h-d)	65x115x135 mm
Weight	0.6 kg approx.

Input Data

Nominal Input Voltage Vac	115 – 230– 277
Voltage range Vac	90 ÷ 305
Inrush Current ($V_n - I_n$ nom. Load) I^2t	$\leq 11 \text{ A} \leq 5 \text{ msec.}$
Frequency	47 ÷ 63 Hz
Input Current (115 – 230 – 277 Vac) Max	2.8- 1.5 - 1.38 A
Internal fuse (not replaceable)	4 A
External Fuse (recommended) MCB curve B	10 A

Output Data (internal power supply)

Output Voltage (V_n) / Nominal Current (I_n)	12 Vdc / 6A
Output Current $I_n = I_{load}$	6 A
Efficiency (at 50% of rated current)	$\geq 90 \%$
Ripple and Noise (20 MHz Bandwidth)	80 mV _{pp} (max)
Turn-On delay after applying mains voltage	1 sec. (max)
Start up with Strong Load (capacitive load)	Yes, Unlimited
Dissipation power load max (W)	17
Current Short Circuit I_{cc} . Max 2 sec.: Hiccup mode 60°C. Restart automatically.	$I_n \times 3.5$
Over Load protection	Yes
Over Voltage Output protection	Yes (typ. 35 Vdc)
Overheating Thermal protection	Yes

Battery Output

Output Voltage Battery	Follow the Out Load
Boost-Fast charge Jumper	Lead Acid: 2.4
Configuration 25°C (V/cell). Jumper	NiCd:1.51; Li-ion: 3.65
Configuration battery type	

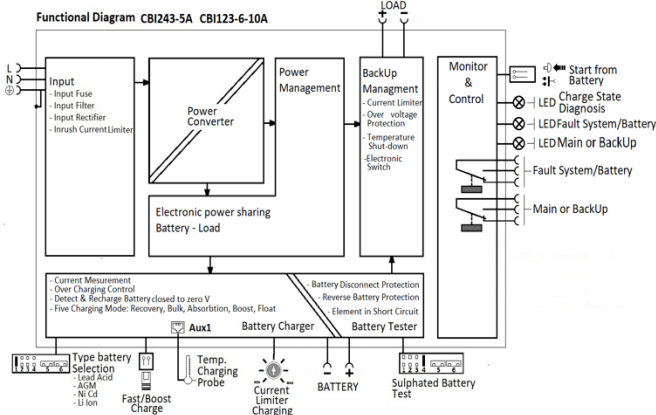

Norms and Certifications

In Conformity to: eNEC EN60950 / UL60950-1 and CSA C22.2 No. 60950-1-07 (Information Technology Equipment) – Safety – Part1: General Requirement. Electrical safety; Electrical safety: EN54-4 and EN12101-10; 89/336/EEC EMC Directive; 2014/35/UE (Low Voltage); Safety EN IEC 62368-1: 2014/AC:2015; DIN41773 (Charging cycle); Emission: IEC 61000-6-3; Immunity: IEC 61000-6-2. CE.

Climatic Data

Ambient temperature (operation)	-25 ÷ +70°C
De Rating $T^a > 50^\circ\text{C}$	- 2.5%(I_n) / °C

¹Can be adjusted via PC software mode

All specifications are subject to change without notice
 CBI126A Data sheet _R37.docx

Float Charge Jumper Configuration 25°C (V/cell)	Lead Acid: 2.23; 2.25;2.27;2.3
Jumper Configuration battery type	NiCd:1.4; Li-ion: 3.45
Max.Time Boost–Bulk charge (Typ. at IN)	15 h
Min.Time Boost–Bulk charge (Typ. at IN)	1 min.
Recovery Charge	2 – 10 Vdc
Charging current max I_{batt}	6 A ± 5%
Charging current limiting I_{adj}	20 ÷ 100 % / I_{bat}
Reverse battery protection	Yes
Sulfated battery check	Yes by Jumper
Short circuit Element Detection	Yes
Detection of element in short circuit	Yes
Quiescent Current max.	≤ 100 mA
Charging Curve automatic: IUoU	4 stage
Remote Input Control (RTCONN cable)	Boost / Float
Load Output	
Output voltage Vdc (at I_n)	10 - 14.4 V (17 Ni-Cd)
Nominal current I_{load}	1.1 x I_n A ± 5%
Continuous current (Without battery) $I_{load= I_n}$	6 A
Continuous current (With battery) $I_{load= I_n + I_{batt}}$	12 A
Max. current Output Load (Main) $I_{load = I_n + I_{batt}}$	18 A max.
Max. current Output Load (Back Up) $I_{load = I_n + I_{batt}}$	12 A max.
Start From Battery Without Main (Remote Input Control)	RTCONN (cable) Push Button
Time Buffering; min (switch output off without main input)	∞: standard 5 min.: Require SW
Threshold alarm Battery almost flat	11.5 – 12 Vdc batt
LVD. (Protections against total Battery discharge)	10 – 11 Vdc batt
Signal Output (free switch contacts)	
Main or Backup Input Power	Yes
Low Battery	Yes
Fault Battery or system	Yes
Type of Signal Output Contact	
Dry Contact. Current can be switched (EN60947.4.1): Max: DC1: 30 Vdc 1 A; AC1: 60 Vac 1A (Resistive load) Min: 1mA at 5 Vdc (Min permissive load)	
Fault System / Low Battery	C NC NO
Main or Back Up	C NC NO
Signal Input / Output (RJ45)	
Temp. Comp. Battery (with external probe): Aux Out	RJ Temp (cable)
Remote monitoring LED from Front Device: Aux Out	RJ 45 (cable)
Accessory	
RTCONN	Cable Start from battery Length 1m. Jumper 6
RJTEMP451	Temperature Probe Length 1m.
RJTEMP453	Temperature Probe Length 3m.
RJ45COUPLER	RJ45 Three way "Daisy Chain" for Aux 2
DPY353	Display for: Monitoring the Battery state, Battery Charging Section.

¹Can be adjusted via PC software mode

All specifications are subject to change without notice
CBI126A Data sheet _R37.docx

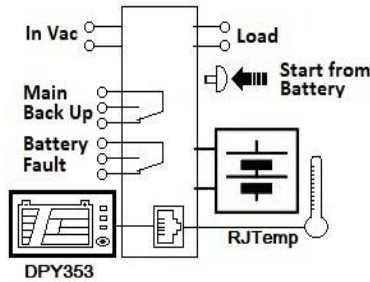

Input: Single-phase 115 – 277 Vac
Output Load: power supply 12 Vdc; 10 A
Output Battery: charging 12 Vdc; 10 A
 Suited for the following battery types: Open Lead Acid, Sealed Lead Acid, Lead Gel, Li-Ion and Ni-Cd
 Automatic diagnostic of battery status. Charging curve IUoU, constant voltage and constant current Battery Life Test function (Battery Care)
 Switching technology, output voltage 10-14.4Vdc Three charging levels: Boost, Float and Recovery
 Protected against short circuit and inverted polarity
 Signal output (contact free) for discharged or damaged battery
 Signal output (contact free) for mains or Back-UP
 Protection degree IP20 - DIN rail; Space saving

Technical features

Thanks to the All In One units (DC-UPS), it will be possible to optimize power management. The available power is automatically allocated between load and battery, supplying power to the load is the first priority of the unit thus it is not necessary to double the power, because also the power going to the battery will go to the load if the load so requires. The maximum available current on the load output is 2 times the value of the device rated current I_n . We call "Battery Care" the concept base on algorithms that implement rapid and automatic charging, battery charge optimization during time, flat batteries recovery and real time diagnostic during installation and operation. The Real Time Auto-diagnostic system, monitoring battery faults such as, battery Sulfated, elements in short circuit, accidental reverse polarity connection, disconnection of the battery, they can easily be detected and removed by help of Blink Code of Diagnosis Led; during the installation and after sell. The continuous monitoring of battery efficiency reduces battery damage risk and allows a safe operation in permanent connection. Each device is suited for all battery types by means of jumpers it is possible setting predefined curves for Open Lead Acid, Sealed Lead Acid, Gel, Ni-Cd (option). They are programmed for two charging levels, boost and charge, but they can be changed to single charging level by the user. A rugged casing with bracket for DIN rail mounting provides IP20 protection degree. They are extremely compact and cost-effective.

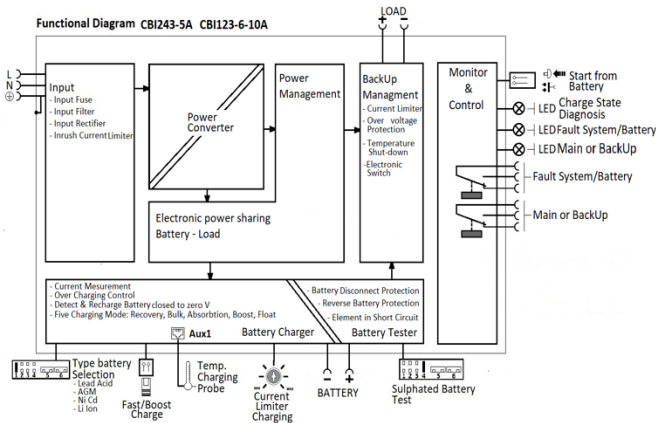

Norms and Certifications

In Conformity to: **eNEC** EN60950 / UL60950-1 and CSA C22.2 No. 60950-1-07 (Information Technology Equipment) – Safety – Part1: General Requirement. Electrical safety; Electrical safety: EN54-4 and EN12101-10; 89/336/EEC EMC Directive; 2014/35/UE (Low Voltage); Safety EN IEC 62368-1: 2014/AC:2015; DIN41773 (Charging cycle); Emission: IEC 61000-6-3; Immunity: IEC 61000-6-2. CE.

Climatic Data

Ambient temperature (operation)	-25 ÷ +70°C
De Rating $T^a > 50^\circ\text{C}$	- 2.5%(I_n) / °C

Ambient temperature Storage	-40 ÷ +85°C
Humidity at 25 °C no condensation	95% to 25°C
Altitude: 0 to 2 000m - 0 to 5 560ft	No restrictions
Altitude: 2 000 to 6 000m - 6 560 to 20 000ft	De-rating 5°C/1000m
Cooling	Auto convection

General Data

Insulation voltage (IN/OUT)	3000 Vac
Insulation voltage (Input / Earth, PE)	2000 Vac
Insulation voltage (Out Load & Battery / Earth, PE)	500 Vac
Insulation voltage (Out Load & Battery / Fault System & Main or Back Up terminal)	500 Vac
Protection Class (EN/IEC 60529)	IP20
Reliability: MTBF IEC 61709	> 300.000 h
Pollution Degree Environment	2
Connection Terminal Blocks screw Type	2,5mm(24–14AWG)

Protection class (PE Connected)	I, with PE
Dimensions (w-h-d)	65x115x135 mm
Weight	0.6 kg approx.

Input Data

Nominal Input Voltage Vac	115 – 230– 277
Voltage range Vac	90 ÷ 305
Inrush Current ($V_n - I_n$ nom. Load) I^2t	$\leq 11 \text{ A} \leq 5 \text{ msec.}$
Frequency	47 ÷ 63 Hz
Input Current (115 – 230 – 277 Vac) Max	2.8- 1.5 - 1.38 A
Internal fuse (not replaceable)	4 A
External Fuse (recommended) MCB curve B	10 A

Output Data (internal power supply)

Output Voltage (V_n) / Nominal Current (I_n)	12 Vdc / 10A
Output Current $I_n = I_{load}$	10 A
Efficiency (at 50% of rated current)	$\geq 90 \%$
Ripple and Noise (20 MHz Bandwidth)	80 mV _{pp} (max)
Turn-On delay after applying mains voltage	1 sec. (max)
Start up with Strong Load (capacitive load)	Yes, Unlimited
Dissipation power load max (W)	17
Current Short Circuit I_{cc} . Max 2 sec.: Hiccup mode 60°C. Restart automatically.	$I_n \times 3.5$
Over Load protection	Yes
Over Voltage Output protection	Yes (typ. 35 Vdc)
Overheating Thermal protection	Yes

Battery Output

Output Voltage Battery	Follow the Out Load
Boost-Fast charge Jumper	Lead Acid: 2.4
Configuration 25°C (V/cell). Jumper	NiCd:1.51; Li-ion: 3.65
Configuration battery type	

¹Can be adjusted via PC software mode

All specifications are subject to change without notice
 CBI1210A Data sheet _R37.docx

Float Charge Jumper Configuration 25°C (V/cell)	Lead Acid: 2.23; 2.25;2.27;2.3
Jumper Configuration battery type	NiCd:1.4; Li-ion: 3.45
Max.Time Boost–Bulk charge (Typ. at IN)	15 h
Min.Time Boost–Bulk charge (Typ. at IN)	1 min.
Recovery Charge	2 – 10 Vdc
Charging current max I_{batt}	10 A ± 5%
Charging current limiting I_{adj}	20 ÷ 100 % / I_{bat}
Reverse battery protection	Yes
Sulfated battery check	Yes by Jumper
Short circuit Element Detection	Yes
Detection of element in short circuit	Yes
Quiescent Current max.	≤ 100 mA
Charging Curve automatic: IUoU	4 stage
Remote Input Control (RTCONN cable)	Boost / Float
Load Output	
Output voltage Vdc (at I_n)	10 - 14.4 V (17 Ni-Cd)
Nominal current I_{load}	1.1 x I_n A ± 5%
Continuous current (Without battery) $I_{load= I_n}$	10 A
Continuous current (With battery) $I_{load= I_n + I_{batt}}$	20 A
Max. current Output Load (Main) $I_{load = I_n + I_{batt}}$ (4 sec.)	30 A max.
Max. current Output Load (Back Up) $I_{load = I_n + I_{batt}}$ (4 sec.)	20 A max.
Start From Battery Without Main (Remote Input Control)	RTCONN (cable) Push Button
Time Buffering; min (switch output off without main input)	∞: standard 5 min.: Require SW
Threshold alarm Battery almost flat	11.5 – 12 Vdc batt
LVD. (Protections against total Battery discharge)	10 – 11 Vdc batt
Signal Output (free switch contacts)	
Main or Backup Input Power	Yes
Low Battery	Yes
Fault Battery or system	Yes
Type of Signal Output Contact	
Dry Contact. Current can be switched (EN60947.4.1): Max: DC1: 30 Vdc 1 A; AC1: 60 Vac 1A (Resistive load) Min: 1mA at 5 Vdc (Min permissive load)	
Fault System / Low Battery	C NC NO
Main or Back Up	C NC NO
Signal Input / Output (RJ45)	
Temp. Comp. Battery (with external probe): Aux Out	RJ Temp (cable)
Remote monitoring LED from Front Device: Aux Out	RJ 45 (cable)
Accessory	
RTCONN	Cable Start from battery Length 1m. Jumper 6
RJTEMP451	Temperature Probe Length 1m.
RJTEMP453	Temperature Probe Length 3m.
RJ45COUPLER	RJ45 Three way "Daisy Chain" for Aux 2
DPY353	Display for: Monitoring the Battery state, Battery Charging Section.

¹Can be adjusted via PC software mode

All specifications are subject to change without notice
CBI1210A Data sheet _R37.docx

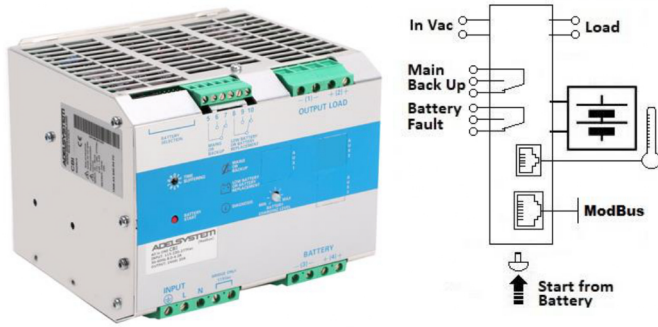

Input: Single-phase 115 – 277 Vac; 550W
Output Load: power supply 12 Vdc; 35 A
Output Battery: charging 12 Vdc; 35 A
Suited for the following battery types: Open Lead Acid, Sealed Lead Acid, Lead Gel, Li-Ion and Ni-Cd
Automatic diagnostic of battery status. Charging curve IUoU, constant voltage and constant current Battery Life Test function (Battery Care)
Switching technology, output voltage 10-14.4 Vdc
Three charging levels: Boost, Float and Recovery
Protected against short circuit and inverted polarity
Signal output (contact free) for discharged or damaged battery
Signal output (contact free) for mains or Back-UP
Protection degree IP20 - DIN rail; Space saving

Technical features

Thanks to the All In One units (DC-UPS), it will be possible to optimize power management. The available power is automatically allocated between load and battery, supplying power to the load is the first priority of the unit thus it is not necessary to double the power, because also the power going to the battery will go to the load if the load so requires. The maximum available current on the load output is 2 times the value of the device rated current I_n . We call "Battery Care" the concept base on algorithms that implement rapid and automatic charging, battery charge optimization during time, flat batteries recovery and real time diagnostic during installation and operation. The Real Time Auto-diagnostic system, monitoring battery faults such as, battery Sulfated, elements in short circuit, accidental reverse polarity connection, disconnection of the battery, they can easily be detected and removed by help of Blink Code of Diagnosis Led; during the installation and after sell. The continuous monitoring of battery efficiency, reduces battery damage risk and allows a safe operation in permanent connection. Each device is suited for all battery types, by means of jumpers it is possible setting predefined curves for Open Lead Acid, Sealed Lead Acid, Gel, Ni-Cd and Li-Ion. They are programmed for two charging levels, boost and charge, but they can be changed to single charging level by the user. A rugged casing with bracket for DIN rail mounting provides IP20 protection degree. They are extremely compact and cost-effective.

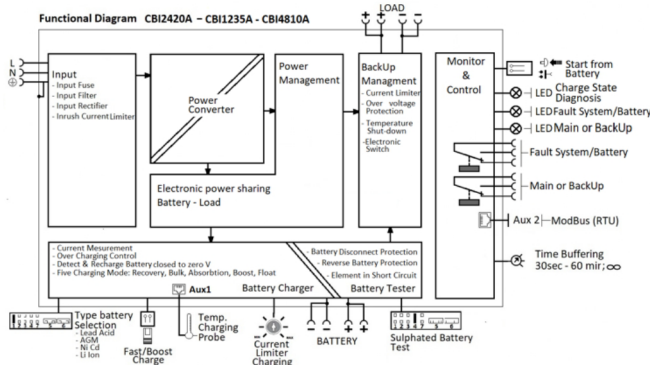

Norms and Certifications

In Conformity to: EN60950 / UL60950-1 and CSA C22.2 No. 60950-1-07 (Information Technology Equipment) – Safety – Part1: General Requirement. Electrical safety; EN54-4 Fire Detection and fire alarm systems; 2014/30/EU EMC Directive; 2014/35/EU Low Voltage Directive; Safety EN IEC 62368-1: 2014/AC:2015; DIN41773 (Charging cycle); Emission: IEC 61000-6-4; Immunity: IEC 61000-6-2. CE.

Climatic Data

Ambient temperature (operation)	-25 ÷ +70°C
De Rating T ³ > 50°C	- 2.5%(In) / °C
Ambient temperature Storage	-40 ÷ +85°C
Humidity at 25 °C no condensation	95% to 25°C
Altitude: 0 to 2 000m - 0 to 6 560ft	No restrictions
Altitude: 2 000 to 6 000m - 6 560 to 20 000ft	De-rating 5°C/1000m
Cooling	Auto

General Data

Insulation voltage (IN/OUT)	3000 Vac
Insulation voltage (Input / Earth, PE)	2000 Vac
Insulation voltage (Out Load & Battery / Earth, PE)	500 Vac
Insulation voltage (Out Load, Battery, Aux2 / Fault System & Main or Back Up terminal)	500 Vac
Protection Class (EN/IEC 60529)	IP20
Reliability: MTBF IEC 61709	> 300.000 h
Pollution Degree Environment	2
Connection Terminal Blocks screw Type	2,5mm(24–14AWG)
Protection class (PE Connected)	I, with PE
Dimensions (w-h-d)	150x115x135 mm
Weight	1.55 kg approx.

Input Data

Nominal Input Voltage Vac	115 – 230– 277
Voltage range Vac	90 – 135 180 – 305
Inrush Current (Vn – In nom. Load) I ² t	≤ 35 A ≤ 5 msec.

Frequency	47 ÷ 63 Hz
Input Current (115 – 230 Vac)	9 – 4.5 A
Internal fuse (not replaceable)	10 A
External Fuse (recommended) MCB curve B	16 A
Output Data (internal power supply)	
Output Voltage (Vn) / Nominal Current (I _n)	12 Vdc
Output Current I _n = I _{load}	35 A
Efficiency (at 50% of rated current)	≥ 91 %
Ripple and Noise (20 MHz Bandwidth)	80 mV _{pp} (max)
Turn-On delay after applying mains voltage	1 sec. (max)
Start up with Strong Load (capacitive load)	Yes, Unlimited
Dissipation power load max (W)	48
Short-circuit protection)	Yes
Over Load protection	Yes
Over Voltage Output protection	Yes (typ. 35 Vdc)
Overheating Thermal protection	Yes

Battery Output

Output Voltage Battery	Follow the Out Load
Boost-Fast charge Jumper Configuration 25°C (V/cell). Jumper Configuration battery type	Lead Acid: 2.4 NiCd:1.45; Li-Ion: 3.65
Float Charge Jumper Configuration 25°C (V/cell) Jumper Configuration battery type	Lead Acid: 2.23;2.25;2.3 NiCd:1.4; Li-Ion: 3.45
Max.Time Boost–Bulk charge (Typ. at IN)	15 h
Min.Time Boost–Bulk charge (Typ. at IN)	1 min.
Recovery Charge	2 – 10 Vdc
Charging current max I _{batt}	35 A ± 5%
Charging current limiting I _{adj}	10 ÷ 100 % / I _{bat}
Reverse battery protection	Yes
Sulfated battery check	Yes by Jumper
Short circuit Element Detection	Yes
Detection of element in short circuit	Yes
Quiescent Current max.	≤ 100 mA
Charging Curve automatic: IUoU	4 stage
Remote Input Control (RTCONN cable)	Boost / Float

Load Output

Output voltage Vdc (at I _n)	10 – 14.4 V (17 Ni-Cd)
Nominal current I _{load}	1.1 x I _n , A ± 5%
Continuous current (Without battery) I _{load} = I _n	35 A
Continuous current (With battery) I _{load} = I _n + I _{batt}	70 A
Max. current Output Load (Main) I _{load} = I _n + I _{batt} (4 sec.)	105 A max.
Max. current Output Load (Back Up) I _{load} = I _n + I _{batt} (4 sec.)	70 A max.
Start From Battery Without Main (Remote Input Control)	RTCONN (cable) Push Button
Time Buffering; min (switch output off without main input)	0.5;2;5;10;15; 20; 30; 45;60;∞
Threshold alarm Battery almost flat	11.2 – 12 Vdc batt
LVD. (Protections against total Batt. discharge)	10 – 11 Vdc batt

Signal Output (free switch contacts)

Main or Backup Input Power	Yes
Low Battery	Yes
Fault Battery or system	Yes

Type of Signal Output Contact

Dry Contact. Current can be switched (EN60947.4.1): Max: DC1: 30 Vdc 1 A; AC1: 60 Vac 1A (Resistive load) Min: 1mA at 5 Vdc (Min permissible load)

Fault System / Low Battery	C	NC	NO
Main or Back Up	C	NC	NO

Signal Input / Output (RJ45)

Temp. Comp. Battery (with external probe)	RJ Temp (cable) Aux 1
Remote monitoring data:	RJ45: Aux 2 ModbusRTU (RS485)
Protocol:	