

# BIC-2200 Series

AC↔DC Bidirectional Power Supply with Energy Recycle Function



Dimension			
L	W	H	
330	140	41 (1U)	mm
13	5.5	1.61(1U)	inch



## Features

- 1U low profile design
- Full digital design with 93% conversion efficiency for both AC/DC and DC/AC conversion
- Ultrafast switching time between AC/DC and DC/AC of 1ms
- CB/TUV/UL 62368-1 and CB/TUV 62477-1 certified
- Active current sharing up to 19800W (up to 9 unit)
- <3% Low THDi in both conversion mode
- Force charging and discharging mode with CANBus model
- Complete protections: Anti-islanding protection, AC fail protection, DC OVP, OLP, OCP, OTP
- Apply BIC-2200 to a three-phase AC power system
- 5 years warranty

## Applications

- Battery cell formation & grading
- V2G (Vehicle-to-grid) system
- Marine battery charger module
- Electric scooter or vehicle charger station
- Kinetic energy recovery system
- Electrolysis system
- Wastewater treatment system

## GTIN CODE

MW Search: <https://www.meanwell.com/serviceGTIN.aspx>

## Description

The BIC-2200 is a 2.2KW bidirectional power supply with energy recycle function. It is fully digital and 1U height designed. It is designed to control the power transferred from AC grid to DC and DC to AC grid for energy recycle. The implementation of a bidirectional power supply of the BIC-2200 allows battery manufactures to charge the battery from AC grid and recycle the DC energy back into AC grid in one single unit. With built-in functions such as active current sharing, remote ON/OFF control and CANBus model available, the BIC-2200 provides vast design flexibility for battery formation & test equipment, V2G(Vehicle-to-grid) system, charging station, laser system and kinetic recovery system.

## Model Encoding / Order Information

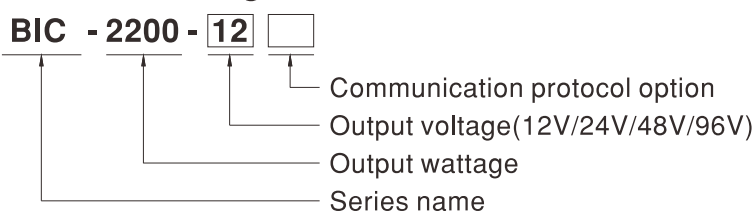

Type	Communication Protocol	Note
Blank	None protocol	In Stock
CAN	CANBus protocol	In Stock

# BIC-2200 Series

AC⇄DC Bidirectional Power Supply with Energy Recycle Function



## SPECIFICATION

MODEL	BIC-2200-12	BIC-2200-24	BIC-2200-48	BIC-2200-96			
AC to DC Direction	DC VOLTAGE	12V	24V	48V	96V		
	RATED CURRENT	180A	90A	45A	22.5A		
	RATED POWER	2160W					
	FULL POWER VOLTAGE RANGE	12 ~ 15V	24 ~ 28V	48 ~ 65V	96 ~ 112V		
	RIPPLE & NOISE (max.) Note.2	160mVp-p	260mVp-p	300mVp-p	480mVp-p		
	VOLTAGE ADJ. RANGE	10 ~ 15V	19 ~ 28V	38 ~ 65V	76 ~ 112V		
	CURRENT RANGE	0 ~ 180A	0 ~ 90A	0 ~ 45A	0 ~ 22.5A		
	VOLTAGE TOLERANCE Note.3	±1.0%	±1.0%	±1.0%	±1.0%		
	LINE REGULATION	±0.5%	±0.5%	±0.5%	±0.5%		
	LOAD REGULATION	±0.5%	±0.5%	±0.5%	±0.5%		
SETUP, RISE TIME	1800ms, 60ms/230VAC at full load						
INPUT	AC VOLTAGE RANGE	180 ~ 264VAC					
	FREQUENCY RANGE	47 ~ 63Hz					
	POWER FACTOR (Typ.)	0.98/230VAC at full load					
	EFFICIENCY (Typ.) Note.5	90%	93%	93%	93%		
	AC CURRENT (Typ.)	11A/230VAC					
	INRUSH CURRENT (Typ.)	COLD START 35A/230VAC					
	LEAKAGE CURRENT	<2mA/230VAC					
TOTAL HARMONIC DISTORTION	<3%(@load=100%/230VAC)						
DC to AC Direction	INPUT (Note.4)	RATED INPUT POWER	1800W				
		FULL POWER VOLTAGE RANGE	12 ~ 15V	24 ~ 28V	48 ~ 65V	96 ~ 112V	
		DC VOLTAGE RANGE	10 ~ 15V	19 ~ 28V	38 ~ 65V	76 ~ 112V	
		MAX. INPUT CURRENT	150A	75A	37.5A	18.75A	
	OUTPUT		OUTPUT POWER (Typ.) (@240V)	1685W	1720W	1720W	1685W
			VOLTAGE RANGE	180 ~ 264VAC determined by AC main			
			FREQUENCY RANGE	47 ~ 63Hz determined by AC main			
			AC CURRENT (Typ.)	7.5A/230VAC			
			POWER FACTOR (Typ.)	0.99/230VAC at full load			
			EFFICIENCY (Typ.) Note.5	90.5%	93%	93%	93%
	TOTAL HARMONIC DISTORTION	<3%(@load=100%/230VAC)					
PROTECTION	OVER LOAD	105 ~ 115% rated output power					
		AC to DC	Constant current limiting, shut down DC O/P voltage 5 sec. after DC O/P voltage is down low, re-power on to recover				
		DC to AC	Not accurate with constant power design				
	SHORT CIRCUIT	Shut down O/P current, re-power on to recover					
	OVER VOLTAGE	17.6 ~ 20.8V	33.6 ~ 39.2V	72.6 ~ 86V	134 ~ 157V		
	Protection type : Shut down O/P voltage, re-power on to recover						
OVER TEMPERATURE	Shut down O/P voltage, recovers automatically after temperature goes down						
ISLANDING PROTECTION	Shut down AC O/P voltage, re-power on to recover						
FUNCTION	REMOTE ON-OFF CONTROL	By electrical signal or dry contact Short: Power ON Open: Power OFF Please refer to the Function Manual infollowing					
	BIDIRECTION SWITCH TIME (Typ.)	1ms					
	ALARM SIGNAL	Isolated TTL signal output for T-Alarm, DC-OK and Fault. Please refer to the Function Manual in following pages					
	AUXILIARY POWER	12V@0.5A tolerance ± 5%, ripple 150mVp-p					
	BATTERY MODE RATED CURRENT(default) Note.7	AC to DC	160A	80A	40A	20A	
		Can be adjusted by communication					
	DC to AC	120A	64A	32A	16A		
		Can be adjusted by communication					
ENVIRONMENT	WORKING TEMP.	-30 ~ +70°C (Refer to "Derating Curve")					
	WORKING HUMIDITY	20 ~ 90% RH non-condensing					
	STORAGE TEMP., HUMIDITY	-40 ~ +85°C, 10 ~ 95% RH non-condensing					
	TEMP. COEFFICIENT	±0.03%/°C (0 ~ 45°C)					
	VIBRATION	10 ~ 500Hz, 2G 10min./1cycle, 60min. each along X, Y, Z axes					
SAFETY & EMC	SAFETY STANDARDS	UL62368-1, IEC62368-1, CAN/CSA C22.2 No.62368-1, TUV BS EN/EN62368-1, EAC TP TC 004, IEC62477-1, TUV BS EN/EN62477-1 approved					
	WITHSTAND VOLTAGE Note.8	I/P-O/P:3KVAC I/P-FG:2KVAC O/P-FG:500VAC					
	ISOLATION RESISTANCE Note.8	I/P-O/P, I/P-FG, O/P-FG:100M Ohms / 500VDC / 25°C / 70% RH					
	EMC EMISSION		BS EN/EN55032				
			Parameter	Standard	Test Level / Note		
			Conducted	BS EN/EN55032 (CISPR32)	Class A		
			Radiated	BS EN/EN55032 (CISPR32)	Class A		
			Harmonic Current	BS EN/EN61000-3-2	Class A		
		Voltage Flicker	BS EN/EN61000-3-3	-----			
	EMC IMMUNITY		BS EN/EN55035, BS EN/EN61000-6-2				
		Parameter	Standard	Test Level / Note			
		ESD	BS EN/EN61000-4-2	Level 3, 8KV air ; Level 2, 4KV contact			
		Radiated	BS EN/EN61000-4-3	Level 3			
		EFT / Burst	BS EN/EN61000-4-4	Level 3			
		Surge	BS EN/EN61000-6-2	2KV/Line-Line 4KV/Line-Earth			
		Conducted	BS EN/EN61000-4-6	Level 3			
		Magnetic Field	BS EN/EN61000-4-8	Level 4			
	Voltage Dips and Interruptions	BS EN/EN61000-4-11	>95% dip 0.5 periods, 30% dip 25 periods, >95% interruptions 250 periods				
OTHERS	MTBF	462.9K hrs min. Telcordia SR-332 (Bellcore) ; 46K hrs min. MIL-HDBK-217F (25°C)					
	DIMENSION	330*140*41mm (L*W*H)					
	PACKING	2.9Kg; 4pcs/12.6Kg/1.25CUFT					
NOTE	<ol style="list-style-type: none"> <li>All parameters NOT specially mentioned are measured at 230VAC input, rated load and 25°C of ambient temperature.</li> <li>Ripple &amp; noise are measured at 20MHz of bandwidth by using a 12" twisted pair-wire terminated with a 0.1uF &amp; 47uF parallel capacitor.</li> <li>Tolerance : includes set up tolerance, line regulation and load regulation.</li> <li>As a constant power output, the driver will auto derating the current limitation when voltage raise above rated voltage(12V,24V,48V,96V) in order to remain 1800W output. On the other hand, when voltage is below rated voltage(12V,24V,48V,96V), the maximum current limitation will set at Max input current.</li> <li>The efficiency is measured at 75% load.</li> <li>The ambient temperature derating of 5°C/1000m with fan models for operating altitude higher than 2000m(6500ft).</li> <li>CANBus model only.</li> <li>During withstandards voltage and isolation resistance testing, the screw "A" shall be temporarily removed, and shall be installed back after the testing.</li> </ol> <p>※ Product Liability Disclaimer : For detailed information, please refer to <a href="https://www.meanwell.com/serviceDisclaimer.aspx">https://www.meanwell.com/serviceDisclaimer.aspx</a></p>						

# BIC-2200 Series

AC↔DC Bidirectional Power Supply with Energy Recycle Function



## ■ BLOCK DIAGRAM

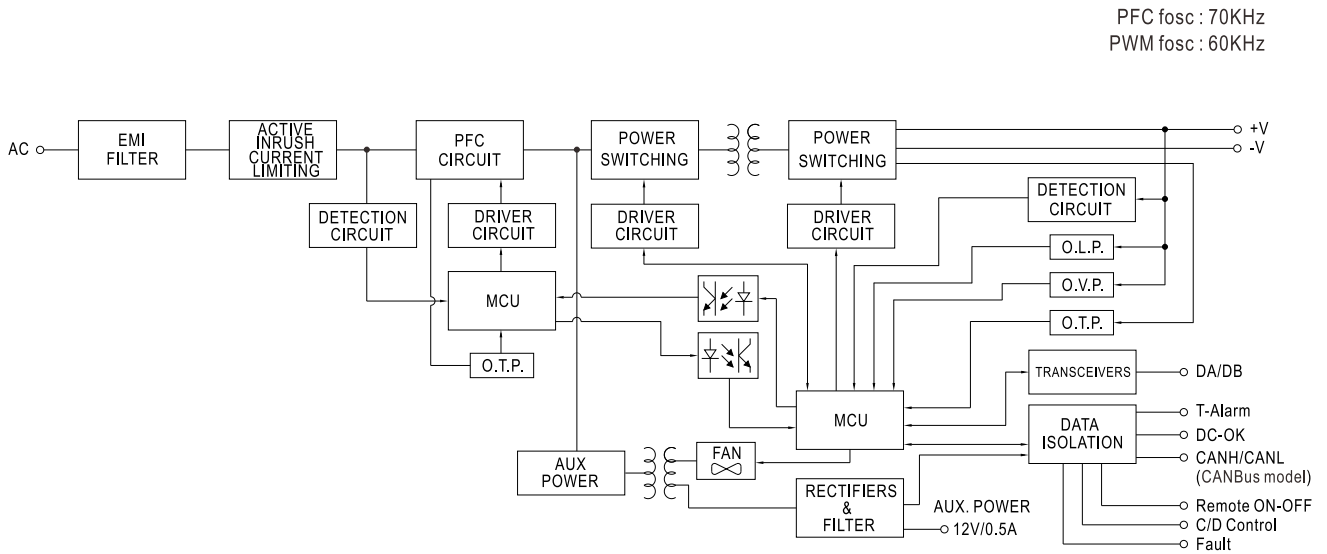

## ■ DERATING CURVE

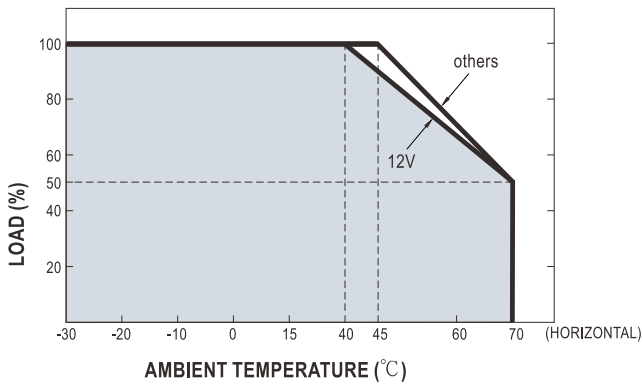

## ■ STATIC CHARACTERISTICS

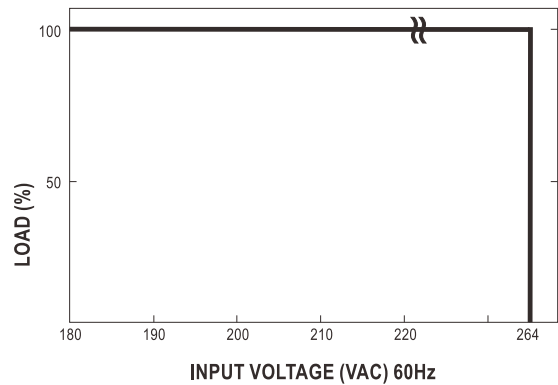

# BIC-2200 Series

AC⇌DC Bidirectional Power Supply with Energy Recycle Function



## MECHANICAL SPECIFICATION

(Unit: mm, tolerance ± 0.5mm)

Case No. 277C

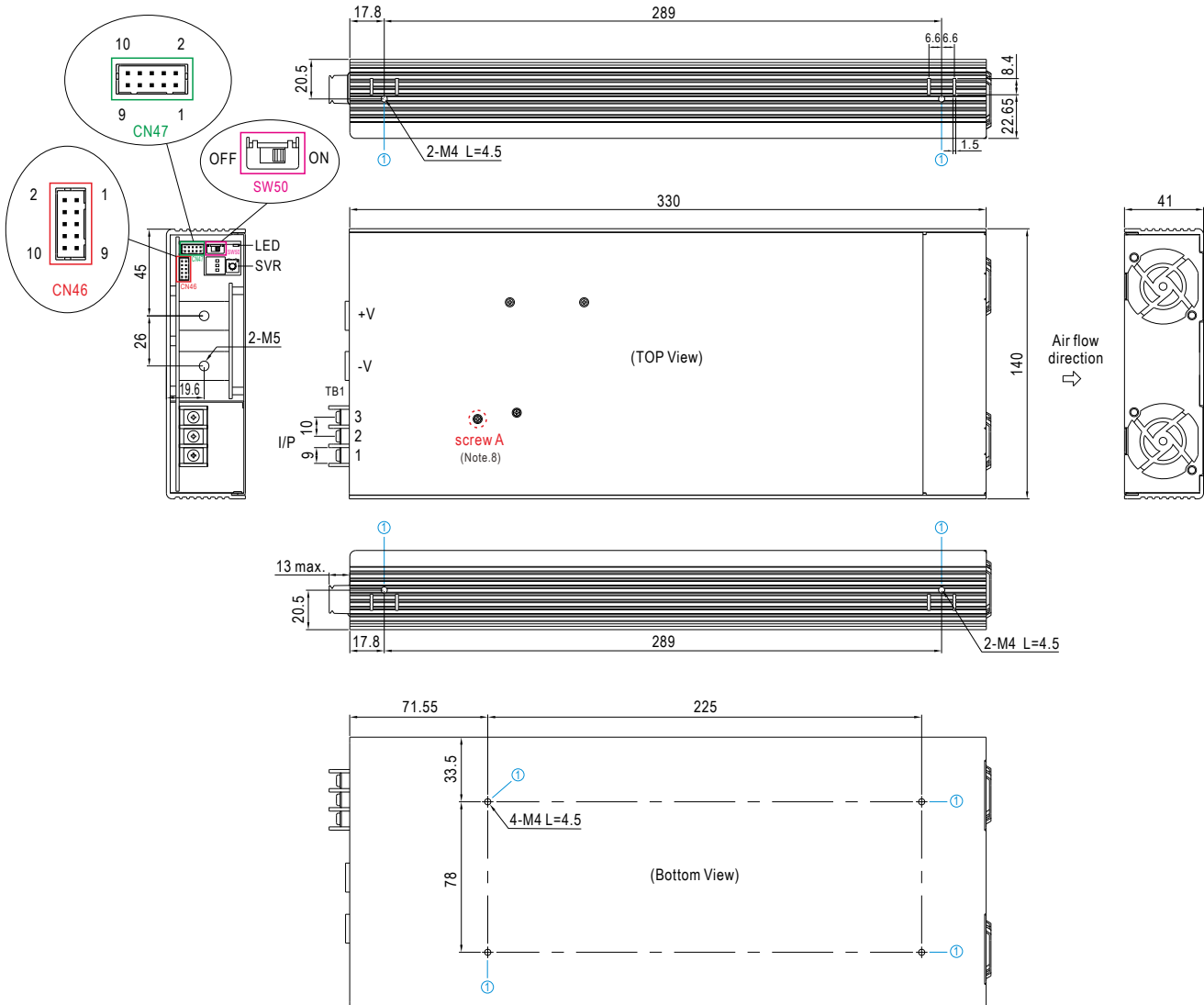

AC Input Terminal(TB1) Pin NO. Assignment

Pin No.	Assignment	Terminal	Max mounting torque
1	AC/L	DECA T35-EO32-03	18Kgf-cm
2	AC/N		
3	FG $\perp$		

DC Output Terminal Pin No. Assignment

Assignment	Diagram	Maximum mounting torque
+V, -V		10Kgf-cm

### LED Status Indicators

LED	Description
	Green AC to DC Direction, functions as regular power supply.
	Green DC to AC Direction, functions as grid inverter.
	Red Abnormal status (Over temperature protection, Overload protection, Fan fail.)

- Light
- Flash

### Mounting Instruction

Hole No.	Recommended Screw Size	MAX. Penetration Depth L	Recommended mounting torque
①	M4	4.5mm	7~10Kgf-cm

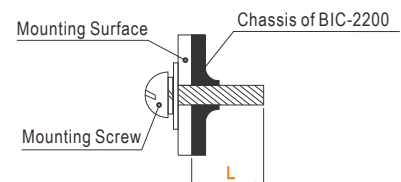

※Control Pin No. Assignment(CN46) : HRS DF11-10DP-2DS or equivalent

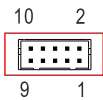

Mating Housing	HRS DF11-10DS or equivalent
Terminal	HRS DF11-10SC or equivalent

Pin No.	Function	Description
1	+12V-AUX	Auxiliary voltage output, 11.4~12.6V, referenced to GND-AUX (pin 2,4). The maximum output current is 0.5A. This output is not controlled by the Remote ON/OFF control.
2,4	GND-AUX	Auxiliary voltage output GND. The signal return is isolated from the output terminals (+V & -V).
3	+5V-AUX	Auxiliary voltage output, 4.5~5.5V, referenced to GND-AUX (pin 2,4) only for Remote ON/OFF used. This output is not controlled by the Remote ON/OFF control.
5	Remote ON-OFF	The unit can turn the output ON/OFF by electrical signal or dry contact between Remote ON/OFF and +5V-AUX(pin 3). (Note.1)
6	C/D Control (Note.2)	High (4.5 ~ 5.5V) : Battery Charging mode Low (-0.5 ~ 0.5V) : Battery Discharging mode (Note.1)
7	DC-OK	High (4.5 ~ 5.5V) : When the $V_{out} \leq 80\% \pm 5\%$ . Low (-0.5 ~ 0.5V) : When $V_{out} \geq 80\% \pm 5\%$ . The maximum sourcing current is 4mA and only for output. (Note.1)
8	Fault	High (4.5 ~ 5.5V) : When the $V_{ac} \leq 165V_{rms}$ , OLP, SCP, OTP, OVP, AC Fail, fan lock, islanding protection. Low (-0.5 ~ 0.5V) : When $V_{ac} \geq 175V_{rms}$ and when power supply work normally. The maximum sourcing current is 4mA and only for output. (Note.1)
9	T-ALARM	High (4.5 ~ 5.5V) : When the internal temperature exceeds the limit of temperature alarm, or when any of the fans fails. Low (-0.5 ~ 0.5V) : When the internal temperature is normal, and when fans work normally. The maximum sourcing current is 4mA and only for output(Note.1)
10	NC	----

Note 1 : Isolated signal, referenced to GND-AUX.

Note 2 : CANBus model only.

※Control Pin No. Assignment(CN47): HRS DF11-10DP-2DS or equivalent

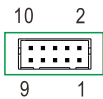

Mating Housing	HRS DF11-10DS or equivalent
Terminal	HRS DF11-10SC or equivalent

Pin No.	Function	Description
1,2	DA	Differential digital signal for parallel control. (Note.1)
3,4	DB	
5,6	GND	Negative output voltage signal. Certain function reference. It can not be connected directly to the load.
7	CANH (CANBus model)	For CANBus model: Data line used in CANBus interface. (Note.2)
8	CANL (CANBus model)	For CANBus model: Data line used in CANBus interface. (Note.2)
9,10	GND-AUX	Auxiliary voltage output GND. The signal return is isolated from the output terminals (+V & -V).

Note 1 : Non-isolated signal, referenced to GND.

Note 2 : Isolated signal, referenced to GND-AUX.

### ◎ Bidirection process

BIC-2200 possesses AC to DC and DC to AC two way conversion functions. The conversion direction can be automatically detected and controlled by BIC-2200's internal firmware or manually switched by users according to different application requirements. Before entering detailed function explanation. Please refer to following definitions.

AC to DC (Energy absorbing and charging/ power supplying):

The BIC-2200 converts AC energy from the grid into DC energy for the battery or the loads. The operation principle is the same as an ordinary power supply or a charger.



DC to AC (Energy recycling and discharging):

Opposite to the AC to DC conversion, the BIC-2200 converts DC energy from the battery or loads into AC energy, then feeding back to the grid. AC output synchronization range is 180Vac~264Vac/47Hz~63Hz, the bidirectional power supply can work normally as long as the AC grid is within the range.



Bi-direction auto-detect mode:

This is default factory setting, BIC-2200 operates as table below

Condition	Mode
Set voltage > load voltage	AC to DC
Set voltage < load voltage	DC to AC

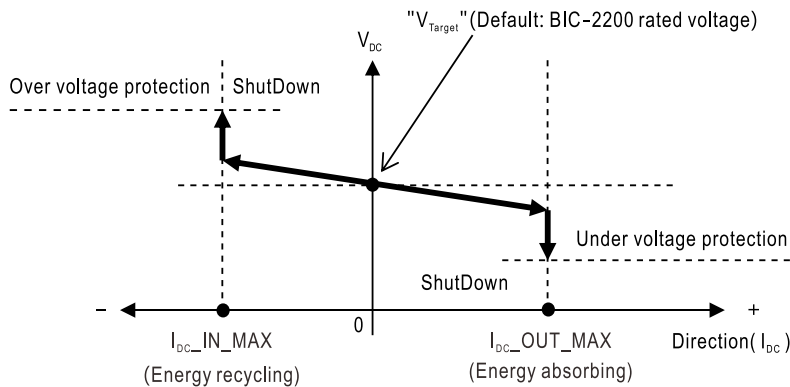

Operating characteristic curve

Note:Detail of set voltage, please refer to user's manual.

Bi-direction battery mode:

This mode only can be activated by CANBus model. Set the BIC-2200 in AC to DC (charging) or DC to AC (discharging) conversion directly through command DIRECTION\_CTRL below.

Command	Conversion
DIRECTION_CTRL = 00h	AC to DC (charging)
DIRECTION_CTRL = 01h	DC to AC (discharging)

### ◎ Current Sharing

BIC-2200 has the built-in active current sharing function and can be connected in parallel, up to 9 units, to provide higher output power as exhibited below :

- ※ The power supplies should be paralleled using short and large diameter wiring and then connected to the load.
- ※ In parallel connection, power supply with the highest output Voltage will be the master unit and its Vout will be the DC bus voltage.
- ※ The total output current must not exceed the value determined by the following equation:  
Maximum output current at parallel operation=(Rated current per unit)×(Number of unit)×0.95
- ※ When the total output current is less than 5% of the total rated current, or say (5% of Rated current per unit)×(Number of unit) the current shared among units may not be balanced.
- ※ CN47/SW50 Function pin connection

Parallel	PSU1		PSU2		PSU3		PSU4		PSU5		PSU6		PSU7		PSU8		PSU9		
	CN47	SW50	CN47	SW50	CN47	SW50	CN47	SW50	CN47	SW50	CN47	SW50	CN47	SW50	CN47	SW50	CN47	SW50	
1 unit	X	ON	—	—	—	—	—	—	—	—	—	—	—	—	—	—	—	—	—
2 unit	V	ON	V	ON	—	—	—	—	—	—	—	—	—	—	—	—	—	—	—
3 unit	V	ON	V	OFF	V	ON	—	—	—	—	—	—	—	—	—	—	—	—	—
4 unit	V	ON	V	OFF	V	OFF	V	ON	—	—	—	—	—	—	—	—	—	—	—
5 unit	V	ON	V	OFF	V	OFF	V	OFF	V	ON	—	—	—	—	—	—	—	—	—
6 unit	V	ON	V	OFF	V	OFF	V	OFF	V	OFF	V	ON	—	—	—	—	—	—	—
7 unit	V	ON	V	OFF	V	OFF	V	OFF	V	OFF	V	OFF	V	ON	—	—	—	—	—
8 unit	V	ON	V	OFF	V	OFF	V	OFF	V	OFF	V	OFF	V	OFF	V	ON	—	—	—
9 unit	V	ON	V	OFF	V	OFF	V	OFF	V	OFF	V	OFF	V	OFF	V	OFF	V	ON	—

(V : CN47 connected ; X : CN47 not connected)

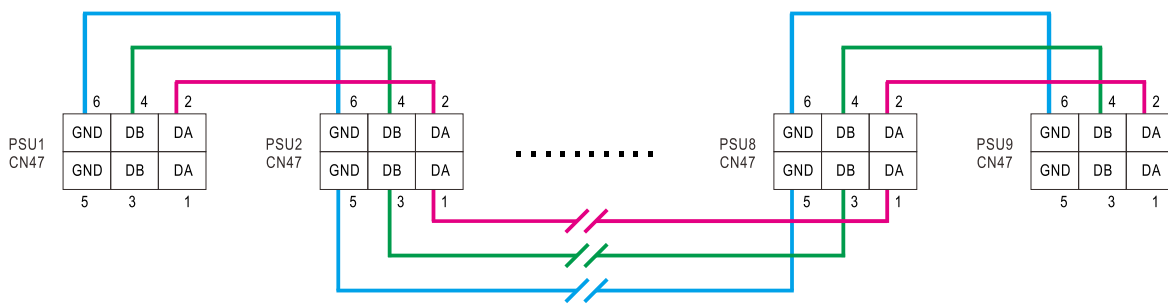
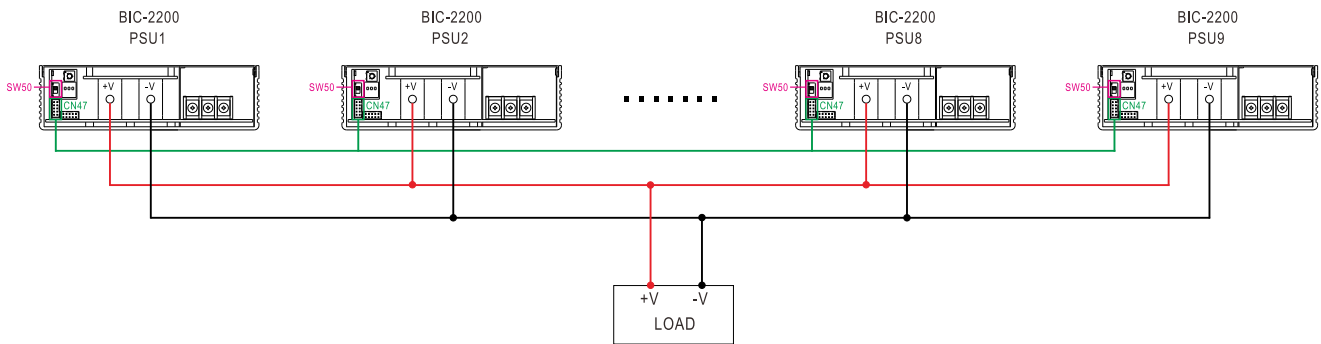

If the lines of CN47 are too long, they should be twisted in pairs to avoid the noise.

◎ DA, DB connected mutually in parallel.

# BIC-2200 Series

AC⇌DC Bidirectional Power Supply with Energy Recycle Function



## © 3-phase 4-wire AC power system

The BIC-2200 can be installed in a 3-phase 4-wire AC power system. To ensure more balanced operation of multiple BIC-2200 units within the system, it is recommended to evenly distribute the bidirectional power supplies across each phase. For example, if 9 units need to be installed, they should be split into 3 for each phase.

